

FEATURES

- Ultrasmall package:** 2 mm × 2 mm, 8-lead LFCSP
- High relative accuracy (INL):** ±2 LSB maximum at 16 bits
[AD5693R/AD5692R/AD5691R](#)
- Low drift, 2.5 V reference:** 2 ppm/°C typical
- Selectable span output:** 2.5 V or 5 V
[AD5693](#)
- External reference only**
- Selectable span output:** V_{REF} or 2 × V_{REF}
- Total unadjusted error (TUE):** ±0.06% of FSR maximum
- Offset error:** ±1.5 mV maximum
- Gain error:** ±0.05 % of FSR maximum
- Low glitch:** 0.1 nV-sec
- High drive capability:** 20 mA
- Low power:** 1.2 mW at 3.3 V
- Independent logic supply:** 1.8 V to 5.5 V
- Wide operating temperature range:** -40°C to +105°C
- Robust 4 kV HBM ESD protection**

APPLICATIONS

- Process controls
- Data acquisition systems
- Digital gain and offset adjustment
- Programmable voltage sources
- Optical modules

GENERAL DESCRIPTION

The [AD5693R/AD5692R/AD5691R/AD5693](#), members of the nanoDAC+® family, are low power, single-channel, 16-/14-/ 12-bit buffered voltage output DACs. The devices, except the [AD5693](#), include an enabled by default internal 2.5 V reference, offering 2 ppm/°C drift. The output span can be programmed to be 0 V to V_{REF} or 0 V to 2 × V_{REF}. All devices operate from a single 2.7 V to 5.5 V supply and are guaranteed monotonic by design. The devices are available in a 2.00 mm × 2.00 mm, 8-lead LFCSP or a 10-lead MSOP.

The internal power-on reset circuit ensures that the DAC register is written to zero scale at power-up while the internal output buffer is configured in normal mode. The [AD5693R/AD5692R/AD5691R/AD5693](#) contain a power-down mode that reduces the current consumption of the device to 2 μA (maximum) at 5 V and provides software selectable output loads.

The [AD5693R/AD5692R/AD5691R/AD5693](#) use an I²C interface. Some device options also include an asynchronous RESET pin and a V_{LOGIC} pin, allowing 1.8 V compatibility.

Rev. B

[Document Feedback](#)

Information furnished by Analog Devices is believed to be accurate and reliable. However, no responsibility is assumed by Analog Devices for its use, nor for any infringements of patents or other rights of third parties that may result from its use. Specifications subject to change without notice. No license is granted by implication or otherwise under any patent or patent rights of Analog Devices. Trademarks and registered trademarks are the property of their respective owners.

FUNCTIONAL BLOCK DIAGRAM

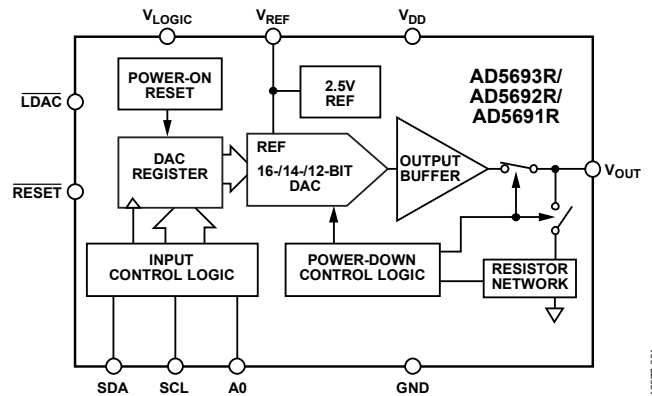
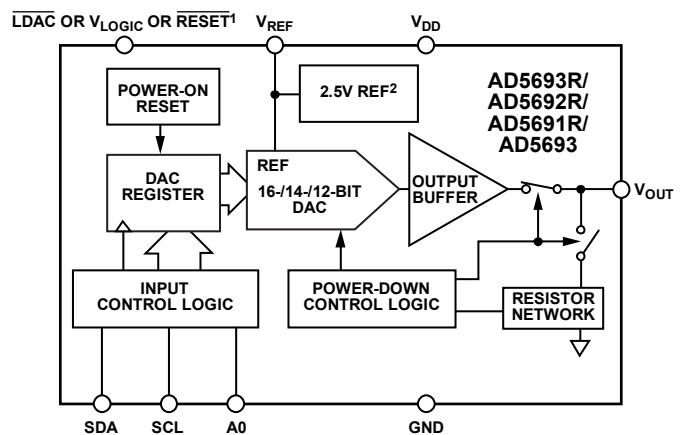

Figure 1. MSOP



- ¹NOT ALL PINS AVAILABLE IN ALL 8-LEAD LFCSP MODELS.
²NOT AVAILABLE IN THE AD5693.

Figure 2. LFCSP

Table 1. Related Devices

Interface	Reference	16-Bit	14-Bit	12-Bit
SPI	Internal	AD5683R	AD5682R	AD5681R
	External	AD5683		
I ² C	Internal	AD5693R	AD5692R	AD5691R
	External	AD5693		

PRODUCT HIGHLIGHTS

1. High relative accuracy (INL): ±2 LSB maximum ([AD5693R/AD5693](#), 16-bit).
2. Low drift, 2.5 V on-chip reference: 2 ppm/°C typical and 5 ppm/°C maximum temperature coefficient.
3. 2 mm × 2 mm, 8-lead LFCSP and 10-lead MSOP.

TABLE OF CONTENTS

Features	1	Digital-to-Analog Converter	19
Applications	1	Transfer Function	19
General Description	1	DAC Architecture	19
Functional Block Diagram	1	Serial Interface	20
Product Highlights	1	I ² C Serial Data Interface	20
Revision History	2	I ² C Address	20
Specifications	3	Write Operation	20
AC Characteristics	5	Read Operation	22
Timing Characteristics	5	Load DAC (Hardware $\overline{\text{LDAC}}$ Pin)	23
Absolute Maximum Ratings	7	Hardware $\overline{\text{RESET}}$	23
Thermal Resistance	7	Thermal Hysteresis	23
ESD Caution	7	Power-Up Sequence	23
Pin Configurations and Function Descriptions	8	Recommended Regulator	24
Typical Performance Characteristics	12	Layout Guidelines	24
Terminology	18	Outline Dimensions	25
Theory of Operation	19	Ordering Guide	26

REVISION HISTORY

11/14—Rev. A to Rev. B

Changes to Figure 2	1
Changes to Table 8	9
Change to Figure 7	10
Added Table 9; Renumbered Sequentially	10
Added Figure 8; Renumbered Sequentially, and Table 10	11
Added Recommended Regulator Section	24
Changes to Ordering Guide	26

5/14—Rev. 0 to Rev. A

Added AD5693	Universal
Changes to Features, General Description, Figure 2, Table 1, and Product Highlights	1
Added AD5693 Parameter, Table 1 and AD5693 Parameter, Table 1	3

Changes to Endnote 1, Specifications Section, Table 1	4
Change to Total Harmonic Distortion, AC Characteristics, Table 3 and Endnote 2, Table 3	5
Changes to Endnote 7, Timing Characteristics, Table 4	5
Change to Pin 9, Description, Table 7	8
Changes to Figure 6 and Table 8	9
Change to Figure 11	10
Change to Figure 18	11
Change to the External Reference Section	17
Change to Figure 46	19
Change to Figure 48	20
Change to Figure 50	21
Changes to Ordering Guide	23

2/14—Revision 0: Initial Version

SPECIFICATIONS

$V_{DD} = 2.7\text{ V to }5.5\text{ V}$, $R_L = 2\text{ k}\Omega\text{ to GND}$, $C_L = 200\text{ pF to GND}$, $V_{REF} = 2.5\text{ V to }V_{DD} - 0.2\text{ V}$, $V_{LOGIC} = 1.8\text{ V to }5.5\text{ V}$, $-40^\circ\text{C} < T_A < +105^\circ\text{C}$, unless otherwise noted.

Table 2.

Parameter	Min	Typ	Max	Unit	Test Conditions/Comments
STATIC PERFORMANCE ¹					
AD5693R					
Resolution	16			Bits	
Relative Accuracy (INL)					
A Grade			± 8	LSB	Gain = 2
B Grade			± 2	LSB	Gain = 1
Differential Nonlinearity			± 3	LSB	Guaranteed monotonic by design
			± 1	LSB	
AD5692R					
Resolution	14			Bits	
Relative Accuracy			± 4	LSB	
Differential Nonlinearity			± 1	LSB	Guaranteed monotonic by design
AD5691R					
Resolution	12			Bits	
Relative Accuracy					
A Grade			± 2	LSB	
B Grade			± 1	LSB	
Differential Nonlinearity			± 1	LSB	Guaranteed monotonic by design
AD5693					
Resolution	16			Bits	
Relative Accuracy (INL)			± 2	LSB	Gain = 2
			± 3	LSB	Gain = 1
Differential Nonlinearity			± 1	LSB	Guaranteed monotonic by design
Zero Code Error			1.25	mV	All 0s loaded to DAC register
Offset Error			± 1.5	mV	
Full-Scale Error			± 0.075	% of FSR	All 1s loaded to DAC register
Gain Error			± 0.05	% of FSR	
Total Unadjusted Error			± 0.16	% of FSR	Internal reference, gain = 1
			± 0.14	% of FSR	Internal reference, gain = 2
			± 0.075	% of FSR	External reference, gain = 1
			± 0.06	% of FSR	External reference, gain = 2
Zero Code Error Drift		± 1		$\mu\text{V}/^\circ\text{C}$	
Offset Error Drift		± 1		$\mu\text{V}/^\circ\text{C}$	
Gain Temperature Coefficient		± 1		ppm/ $^\circ\text{C}$	
DC Power Supply Rejection Ratio		0.2		mV/V	DAC code = midscale, $V_{DD} = 5\text{ V} \pm 10\%$
OUTPUT CHARACTERISTICS					
Output Voltage Range	0		V_{REF}	V	Gain = 0
	0		$2 \times V_{REF}$	V	Gain = 1
Capacitive Load Stability		2		nF	$R_L = \infty$
		10		nF	$R_L = 2\text{ k}\Omega$
Resistive Load	1			k Ω	$C_L = 0\text{ }\mu\text{F}$
Load Regulation		10		$\mu\text{V}/\text{mA}$	$V_{DD} = 5\text{ V}$, DAC code = midscale, $-30\text{ mA} \leq I_{OUT} \leq +30\text{ mA}$
		10		$\mu\text{V}/\text{mA}$	$V_{DD} = 3\text{ V}$, DAC code = midscale, $-20\text{ mA} \leq I_{OUT} \leq +20\text{ mA}$
Short-Circuit Current	20		50	mA	
Load Impedance at Rails ²		20		Ω	

Parameter	Min	Typ	Max	Unit	Test Conditions/Comments
REFERENCE OUTPUT					
Output Voltage	2.4975		2.5025	V	At ambient temperature
Voltage Reference TC ³					See the Terminology section
A Grade		5	20	ppm/°C	
B Grade		2	5	ppm/°C	
Output Impedance		0.05		Ω	
Output Voltage Noise		16.5		μV p-p	0.1 Hz to 10 Hz
Output Voltage Noise Density		240		nV/√Hz	At ambient temperature, f = 10 kHz, C _L = 10 nF
Capacitive Load Stability		5		μF	R _L = 2 kΩ
Load Regulation Sourcing		50		μV/mA	At ambient temperature, V _{DD} ≥ 3 V
Load Regulation Sinking		30		μV/mA	At ambient temperature
Output Current Load Capability		±5		mA	V _{DD} ≥ 3 V
Line Regulation		80		μV/V	At ambient temperature
Thermal Hysteresis		125		ppm	First cycle
		25		ppm	Additional cycles
REFERENCE INPUT					
Reference Current		35		μA	V _{REF} = V _{DD} = V _{LOGIC} = 5.5 V, gain = 1
		57		μA	V _{REF} = V _{DD} = V _{LOGIC} = 5.5 V, gain = 2
Reference Input Range ⁴			V _{DD}	V	
Reference Input Impedance		120		kΩ	Gain = 1
		60		kΩ	Gain = 2
LOGIC INPUTS					
I _{IN} , Input Current			±1	μA	Per pin
			±3	μA	SDA and SCL pins
V _{INL} , Input Low Voltage ⁴			0.3 × V _{DD}	V	
V _{INH} , Input High Voltage ⁴	0.7 × V _{DD}			V	
C _{IN} , Pin Capacitance		2		pF	
LOGIC OUTPUTS (SDA)⁴					
Output Low Voltage, V _{OL}			0.4	V	I _{SINK} = 200 μA
Output High Voltage, V _{OH}	V _{DD} - 0.4			V	I _{SOURCE} = 200 μA
Pin Capacitance		4		pF	
POWER REQUIREMENTS					
V _{LOGIC} ⁵	1.8		5.5	V	
I _{LOGIC} ⁵		0.25	3	μA	V _{IH} = V _{LOGIC} or V _{IL} = GND
V _{DD}	2.7		5.5	V	Gain = 1
	V _{REF} + 1.5		5.5	V	Gain = 2
I _{DD} ⁶					V _{IH} = V _{DD} , V _{IL} = GND
Normal Mode ⁷		350	500	μA	Internal reference enabled
		110	180	μA	Internal reference disabled
Power-Down Modes ⁸			2	μA	

¹ Linearity calculated using a reduced code range: AD5693R/AD5693 (Code 512 to Code 65,535); AD5692R (Code 128 to Code 16,384); AD5691R (Code 32 to Code 4096). Output unloaded.

² When drawing a load current at either rail, the output voltage headroom, with respect to that rail, is limited by the 20 Ω typical channel resistance of the output devices; for example, when sinking 1 mA, the minimum output voltage with 20 Ω, 1 mA generates 20 mV. See Figure 36 for more details.

³ Voltage reference temperature coefficient is calculated as per the box method. See the Terminology section for more information.

⁴ Substitute V_{LOGIC} for V_{DD} if the device includes a V_{LOGIC} pin.

⁵ The V_{LOGIC} pin is not available on all models.

⁶ If the V_{LOGIC} pin is not available, I_{DD} = I_{DD} + I_{LOGIC}.

⁷ Interface inactive. DAC active. DAC output unloaded.

⁸ DAC powered down.

AC CHARACTERISTICS

$V_{DD} = 2.7\text{ V to }5.5\text{ V}$, $R_L = 2\text{ k}\Omega$ to GND, $C_L = 200\text{ pF}$ to GND, $V_{REF} = 2.5\text{ V to }V_{DD} - 0.2\text{ V}$, $V_{LOGIC} = 1.8\text{ V to }5.5\text{ V}$, $-40^\circ\text{C} < T_A < +105^\circ\text{C}$, typical at 25°C , unless otherwise noted.

Table 3.

Parameter	Typ	Max	Unit	Conditions/Comments
Output Voltage Settling Time ^{1,2}	5	7	μs	Gain = 1
Slew Rate	0.7		$\text{V}/\mu\text{s}$	
Digital-to-Analog Glitch Impulse ¹	0.1		$\text{nV}\cdot\text{s}$	± 1 LSB change around major carry, gain = 2
Digital Feedthrough ¹	0.1		$\text{nV}\cdot\text{s}$	
Total Harmonic Distortion ¹	-80		dB	At ambient temperature, BW = 20 kHz, $V_{DD} = 5\text{ V}$, $f_{OUT} = 1\text{ kHz}$
Output Noise Spectral Density ¹	300		$\text{nV}/\sqrt{\text{Hz}}$	DAC code = midscale, 10 kHz
Output Noise	6		$\mu\text{V p-p}$	0.1 Hz to 10 Hz; internal reference
SNR	90		dB	At ambient temperature, bandwidth (BW) = 20 kHz, $V_{DD} = 5\text{ V}$, $f_{OUT} = 1\text{ kHz}$
SFDR	83		dB	At ambient temperature, BW = 20 kHz, $V_{DD} = 5\text{ V}$, $f_{OUT} = 1\text{ kHz}$
SINAD	80		dB	At ambient temperature, BW = 20 kHz, $V_{DD} = 5\text{ V}$, $f_{OUT} = 1\text{ kHz}$

¹ See the Terminology section.

² For the AD5693R/AD5693, to ± 2 LSB. For the AD5692R, to ± 1 LSB. For the AD5691R, to ± 0.5 LSB

TIMING CHARACTERISTICS

$V_{DD} = 2.7\text{ V to }5.5\text{ V}$, $V_{LOGIC} = 1.8\text{ V to }5.5\text{ V}$, $-40^\circ\text{C} < T_A < +105^\circ\text{C}$, unless otherwise noted.

Table 4.

Parameter ¹	Min	Typ	Max	Unit	Description
f_{SCL} ²			400	kHz	Serial clock frequency
t_1	0.6			μs	SCL high time, t_{HIGH}
t_2	1.3			μs	SCL low time, t_{LOW}
t_3	100			ns	Data setup time, $t_{SU; DAT}$
t_4 ³	0		0.9	μs	Data hold time, $t_{HD; DAT}$
t_5	0.6			μs	Setup time for a repeated start condition, $t_{SU; STA}$
t_6	0.6			μs	Hold time (repeated) start condition, $t_{HD; STA}$
t_7	1.3			μs	Bus free time between a stop and a start condition, t_{BUF}
t_8	0.6			μs	Setup time for a stop condition, $t_{SU; STO}$
t_9	20		300	ns	Rise time of SDA signal, t_r
t_{10} ⁴	$20 \times (V_{DD}/5.5\text{ V})$		300	ns	Fall time of SDA signal, t_f
t_{11}	20		300	ns	Rise time of SCL signal, t_r
t_{12} ⁴	$20 \times (V_{DD}/5.5\text{ V})$		300	ns	Fall time of SCL signal, t_f
t_{SP} ⁵	0		50	ns	Pulse width of suppressed spike (not shown in Figure 3)
t_{13}	400			ns	$\overline{\text{LDAC}}$ falling edge to SCL falling edge
t_{14}	400			ns	$\overline{\text{LDAC}}$ pulse width (synchronous mode)
t_{15}	20			ns	$\overline{\text{LDAC}}$ pulse width (asynchronous mode)
t_{16}	75			ns	$\overline{\text{RESET}}$ pulse width
$t_{REF_POWER_UP}$ ⁶		600		μs	Reference power-up (not shown in Figure 3)
$t_{SHUTDOWN}$ ⁷			6	μs	Exit shutdown (not shown in Figure 3)

¹ Maximum bus capacitance is limited to 400 pF. All input signals are specified with $t_r = t_f = 1\text{ ns/V}$ (10% to 90% of V_{DD}) and timed from a voltage level of $(V_{IL} + V_{IH})/2$.

² The SDA and SCL timing is measured with the input filters enabled. Switching off the input filters improves the transfer rate; however, it has a negative effect on the EMC behavior of the device.

³ The master should add at least 300 ns for the SDA signal (with respect to the V_{OH} (min) of the SCL signal) to bridge the undefined region of the falling edge of SCL.

⁴ Substitute V_{LOGIC} for V_{DD} on devices that include a V_{LOGIC} pin.

⁵ Not applicable for standard mode.

⁶ Expect the same timing when powering up the device after V_{DD} is equal to 2.7 V.

⁷ Time to exit power-down to normal mode of AD5693R/AD5692R/AD5691R/AD5693 operation.

Timing Diagrams

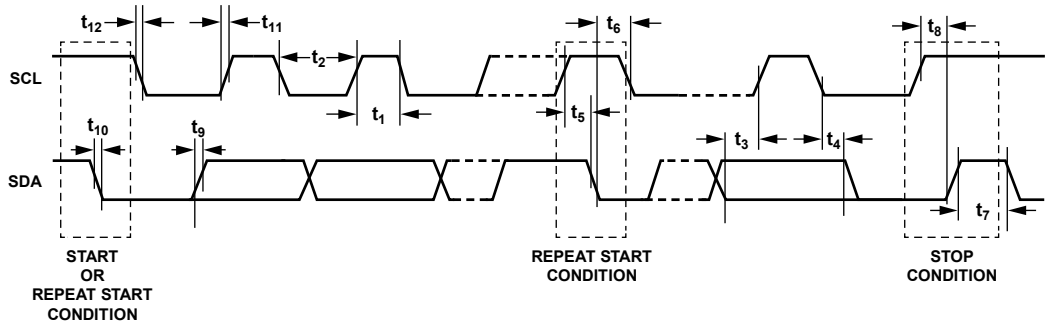

Figure 3. I²C Serial Interface Timing Diagram

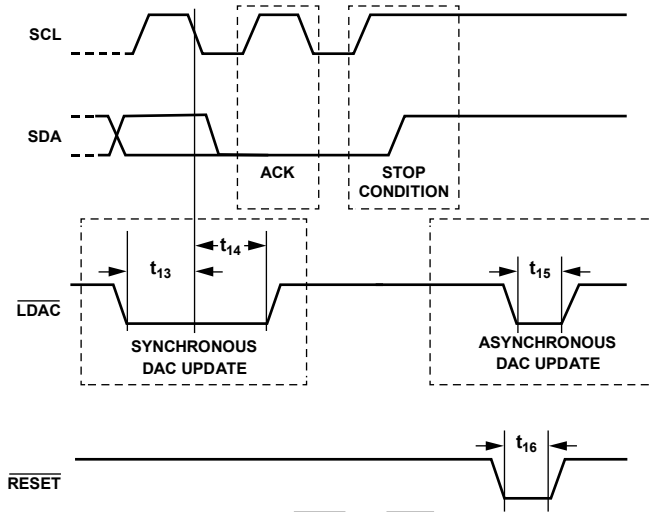

Figure 4. I²C RESET and LDAC Timing

ABSOLUTE MAXIMUM RATINGS

$T_A = 25^\circ\text{C}$, unless otherwise noted.

Table 5.

Parameter	Rating
V_{DD} to GND	-0.3 V to +7 V
V_{LOGIC} to GND	-0.3 V to +7 V
V_{OUT} to GND	-0.3 V to $V_{DD} + 0.3$ V or +7 V (whichever is less)
V_{REF} to GND	-0.3 V to $V_{DD} + 0.3$ V or +7 V (whichever is less)
Digital Input Voltage to GND ¹	-0.3 V to $V_{DD} + 0.3$ V or +7 V (whichever is less)
Operating Temperature Range Industrial	-40°C to +105°C
Storage Temperature Range	-65°C to +150°C
Junction Temperature (T_J max)	135°C
Power Dissipation	$(T_J \text{ max} - T_A)/\theta_{JA}$
ESD ²	4 kV
FICDM ³	1.25 kV

¹ Substitute V_{DD} with V_{LOGIC} on devices that include a V_{LOGIC} pin.

² Human body model (HBM) classification.

³ Field-induced charged-device model classification.

Stresses at or above those listed under Absolute Maximum Ratings may cause permanent damage to the product. This is a stress rating only; functional operation of the product at these or any other conditions above those indicated in the operational section of this specification is not implied. Operation beyond the maximum operating conditions for extended periods may affect product reliability.

THERMAL RESISTANCE

θ_{JA} is defined by the JEDEC JESD51 standard, and the value is dependent on the test board and test environment.

Table 6. Thermal Resistance¹

Package Type	θ_{JA}	θ_{JC}	Unit
8-Lead LFCSP	90	25	°C/W
10-Lead MSOP	135	N/A	°C/W

¹ JEDEC 2S2P test board, still air (0 m/sec airflow).

ESD CAUTION



ESD (electrostatic discharge) sensitive device.

Charged devices and circuit boards can discharge without detection. Although this product features patented or proprietary protection circuitry, damage may occur on devices subjected to high energy ESD. Therefore, proper ESD precautions should be taken to avoid performance degradation or loss of functionality.

PIN CONFIGURATIONS AND FUNCTION DESCRIPTIONS

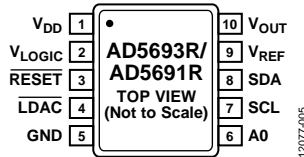

Figure 5. AD5693R/AD5691R Pin Configuration, 10-Lead MSOP

Table 7. AD5693R/AD5691R Pin Function Descriptions, 10-Lead MSOP

Pin No.	Mnemonic	Description
1	V _{DD}	Power Supply Input. These devices can be operated from 2.7 V to 5.5 V. Decouple the supply to GND.
2	V _{LOGIC}	Digital Power Supply. Voltage ranges from 1.8 V to 5.5 V. Decouple the supply to GND.
3	RESET	Hardware Reset Pin. The RESET input is low level sensitive. When RESET is low, the device is reset and external pins are ignored. The input and DAC registers are loaded with zero code value and control register loaded with default values. Tie this pin to V _{LOGIC} if not used.
4	LDAC	Load DAC. Transfers the content of the input register to the DAC register. It can be operated in two modes, asynchronously and synchronously, as shown in Figure 4. This pin can be tied permanently low, and the DAC updates when new data is written to the input register.
5	GND	Ground Reference.
6	A0	Programmable Address for Multiple Package Decoding. The address pin can be updated on-the-fly.
7	SCL	Serial Clock Line.
8	SDA	Serial Data Input/Output.
9	V _{REF}	Reference Input/Output. In the AD5693R/AD5691R, this is a reference output pin by default. It is recommended to use a 10 nF decoupling capacitor for the internal reference.
10	V _{OUT}	Analog Output Voltage from the DAC. The output amplifier has rail-to-rail operation.

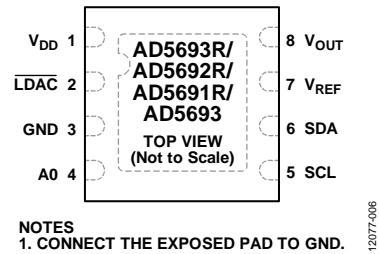
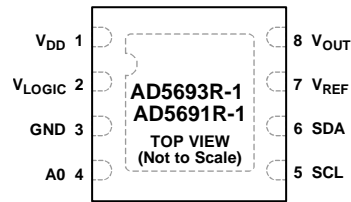

Figure 6. [AD5693R/AD5692R/AD5691R/AD5693](#) Pin Configuration, 8-Lead LFCSP, $\overline{\text{LDAC}}$ Option

Table 8. [AD5693R/AD5692R/AD5691R/AD5693](#) Pin Function Descriptions, 8-Lead LFCSP, $\overline{\text{LDAC}}$ Option

Pin No.	Mnemonic	Description
1	V_{DD}	Power Supply Input. These devices can be operated from 2.7 V to 5.5 V. Decouple the supply to GND.
2	$\overline{\text{LDAC}}$	Load DAC. Transfers the content of the input register to the DAC register. It can be operated in two modes, asynchronously and synchronously, as shown in Figure 4. This pin can be tied permanently low and the DAC updates when new data is written to the input register.
3	GND	Ground Reference.
4	A0	Programmable Address for Multiple Package Decoding. The address pin can be updated on-the-fly.
5	SCL	Serial Clock Line.
6	SDA	Serial Data Input/Output.
7	V_{REF}	Reference Input/Output. In the AD5693R/AD5692R/AD5691R , this is a reference output pin by default. In the AD5693 , this pin is a reference input only. It is recommended to use a 10 nF decoupling capacitor for the internal reference.
8	V_{OUT} EPAD	Analog Output Voltage from the DAC. The output amplifier has rail-to-rail operation. Exposed Pad. Connect the exposed pad to GND.



NOTES
1. CONNECT THE EXPOSED PAD TO GND.

12077-007

Figure 7. AD5693R-1/AD5691R-1 Pin Configuration, 8-Lead LFCSP, V_{LOGIC} Option

Table 9. AD5693R-1/AD5691R-1 Pin Function Descriptions, 8-Lead LFCSP, V_{LOGIC} Option

Pin No.	Mnemonic	Description
1	V _{DD}	Power Supply Input. These devices can be operated from 2.7 V to 5.5 V. Decouple the supply to GND.
2	V _{LOGIC}	Digital Power Supply. Voltage ranges from 1.8 V to 5.5 V. Decouple the supply to GND.
3	GND	Ground Reference.
4	A0	Programmable Address for Multiple Package Decoding. The address pin can be updated on-the-fly.
5	SCL	Serial Clock Line.
6	SDA	Serial Data Input/Output.
7	V _{REF}	Reference Input/Output. In the AD5693R-1/AD5691R-1, this is a reference output pin by default. It is recommended to use a 10 nF decoupling capacitor for the internal reference.
8	V _{OUT} EPAD	Analog Output Voltage from the DAC. The output amplifier has rail-to-rail operation. Exposed Pad. Connect the exposed pad to GND.

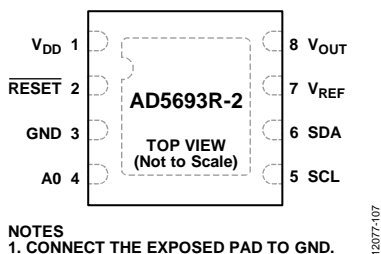

Figure 8. AD5693R-2 Pin Configuration, 8-Lead LFCSP, $\overline{\text{RESET}}$ Option

Table 10. AD5693R-2 Pin Function Descriptions, 8-Lead LFCSP, $\overline{\text{RESET}}$ Option

Pin No.	Mnemonic	Description
1	V_{DD}	Power Supply Input. These devices can be operated from 2.7 V to 5.5 V. Decouple the supply to GND.
2	$\overline{\text{RESET}}$	Hardware Reset Pin. The $\overline{\text{RESET}}$ input is low level sensitive. When $\overline{\text{RESET}}$ is low, the device is reset and external pins are ignored. The input and DAC registers are loaded with zero code value and the control register is loaded with default values. Tie this pin to V_{DD} if not used.
3	GND	Ground Reference.
4	A0	Programmable Address for Multiple Package Decoding. The address pin can be updated on-the-fly.
5	SCL	Serial Clock Line.
6	SDA	Serial Data Input/Output.
7	V_{REF}	Reference Input/Output. In the AD5693R-2, this is a reference output pin by default. It is recommended to use a 10 nF decoupling capacitor for the internal reference.
8	V_{OUT} EPAD	Analog Output Voltage from the DAC. The output amplifier has rail-to-rail operation. Exposed Pad. Connect the exposed pad to GND.

TYPICAL PERFORMANCE CHARACTERISTICS

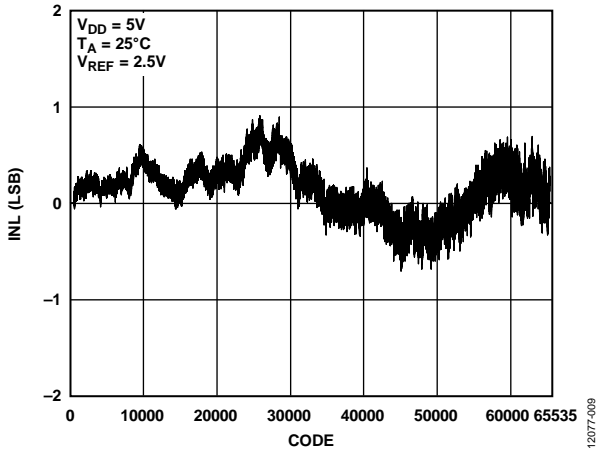

Figure 9. AD5693R/AD5693 INL

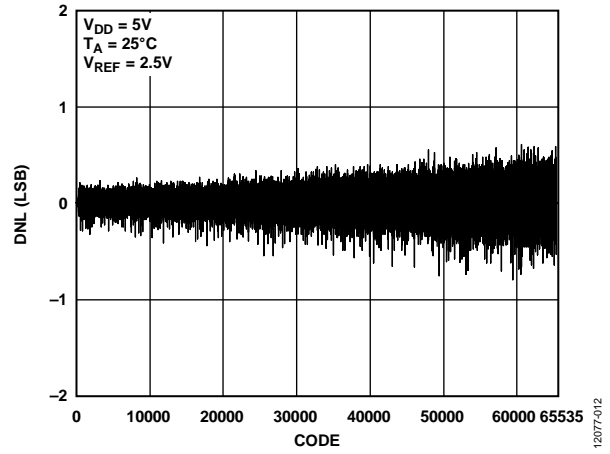

Figure 12. AD5693R/AD5693 DNL

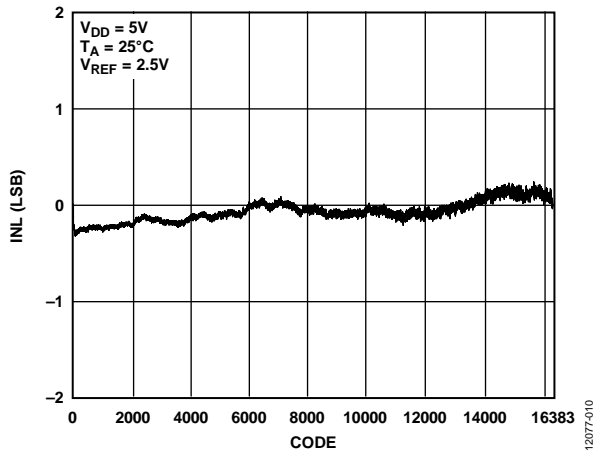

Figure 10. AD5692R INL

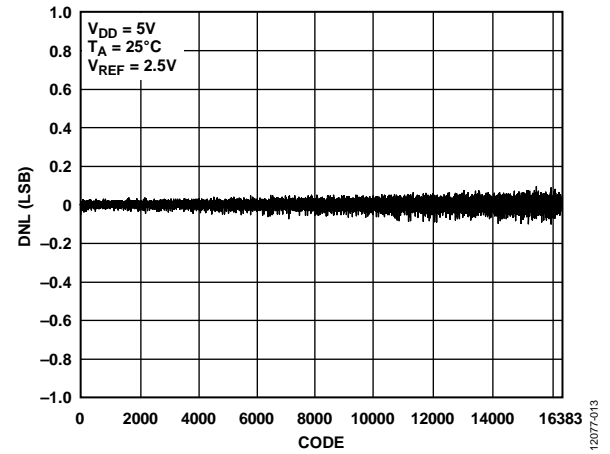

Figure 13. AD5692R DNL

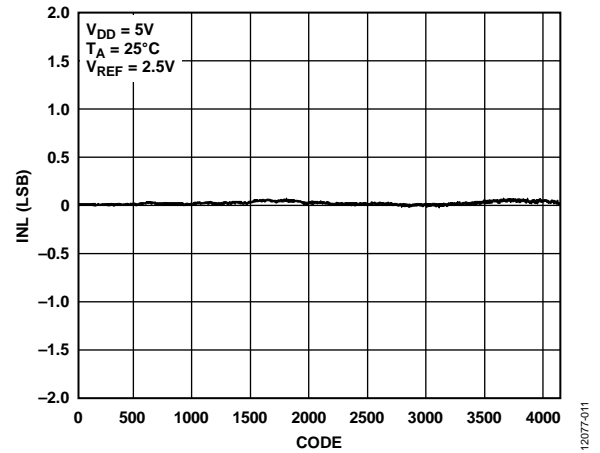

Figure 11. AD5691R INL

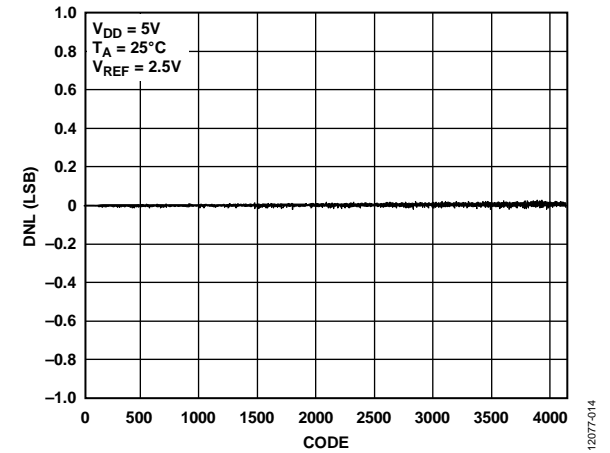

Figure 14. AD5691R DNL

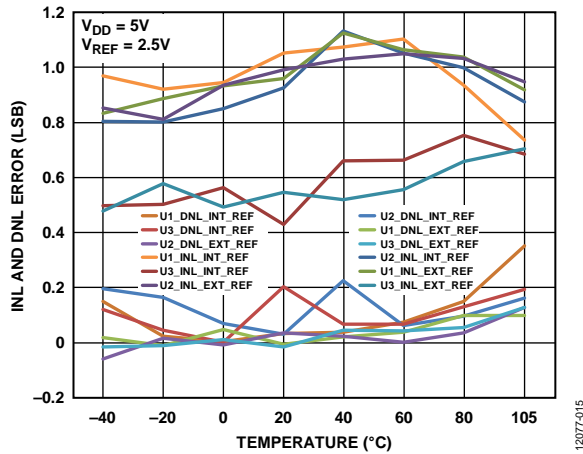

Figure 15. INL and DNL Error vs. Temperature (AD5693R/AD5693)

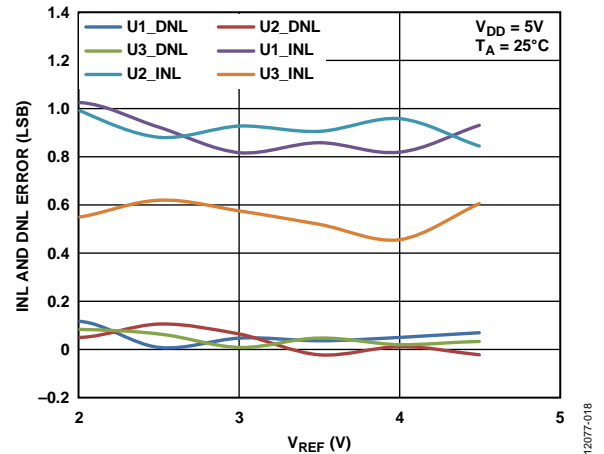

Figure 18. INL and DNL Error vs. V_{REF} (AD5693R/AD5693)

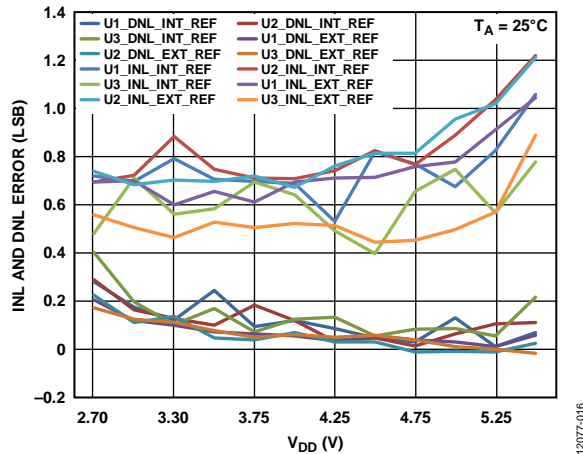

Figure 16. INL and DNL Error vs. V_{DD}

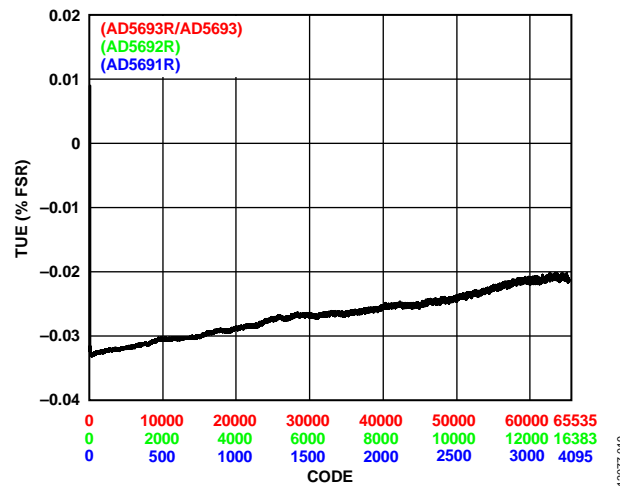

Figure 19. TUE vs. Code

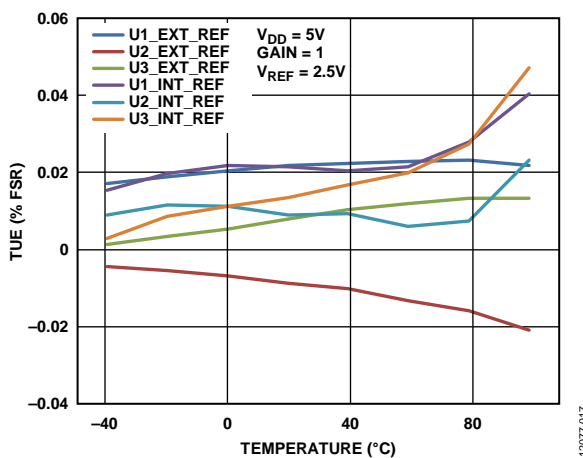

Figure 17. TUE vs. Temperature

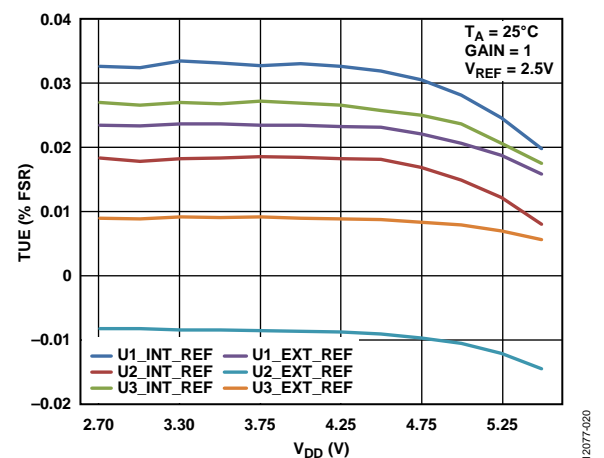

Figure 20. TUE vs. V_{DD}

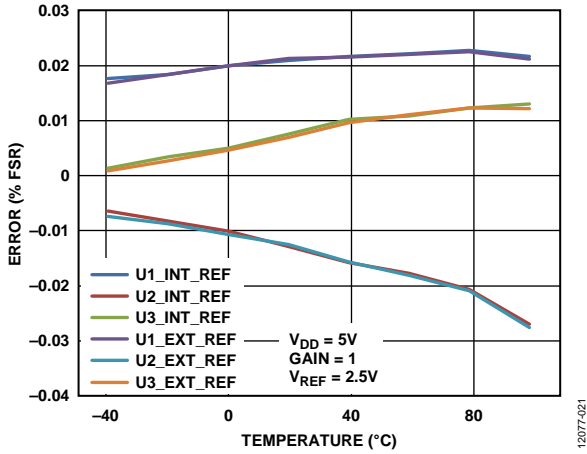

Figure 21. Gain Error and Full-Scale Error vs. Temperature

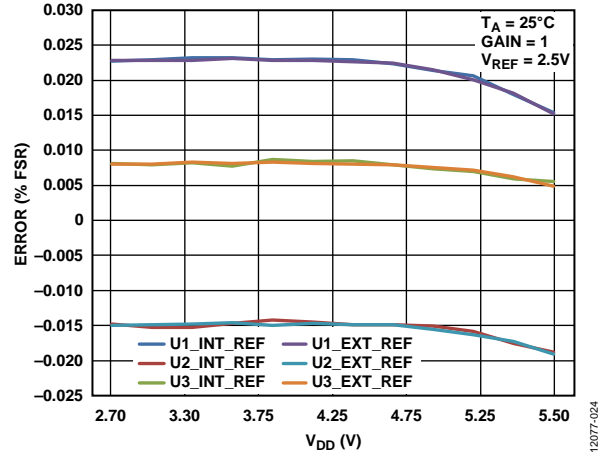

Figure 24. Gain Error and Full-Scale Error vs. V_{DD}

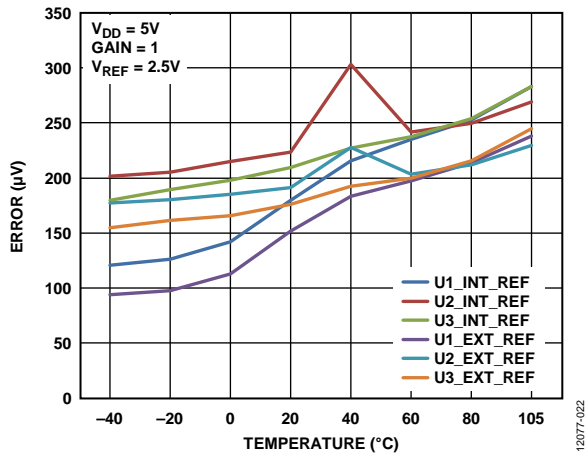

Figure 22. Zero Code Error and Offset Error vs. Temperature

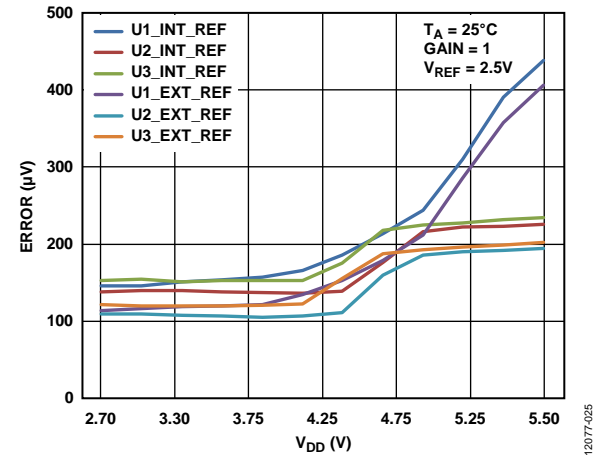

Figure 25. Zero Code Error and Offset Error vs. V_{DD}

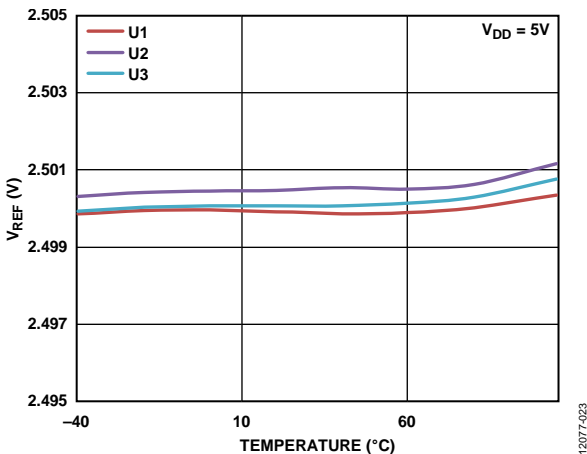

Figure 23. Internal Reference Voltage vs. Temperature (Grade B)

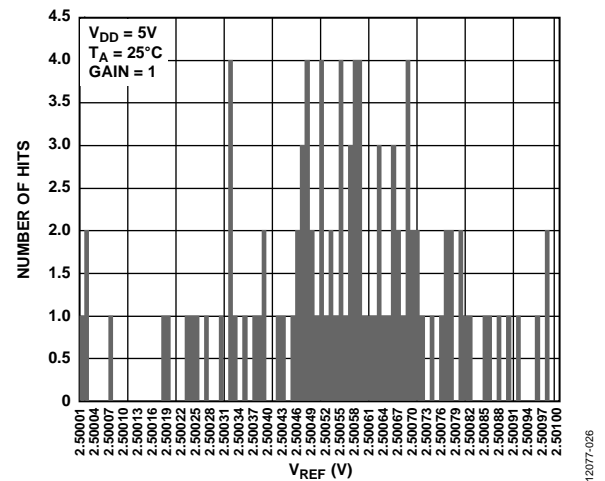

Figure 26. Reference Output Spread

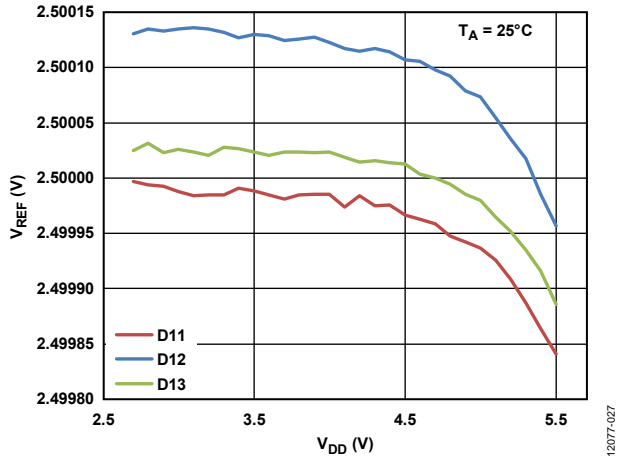

Figure 27. Internal Reference Voltage vs. V_{DD}

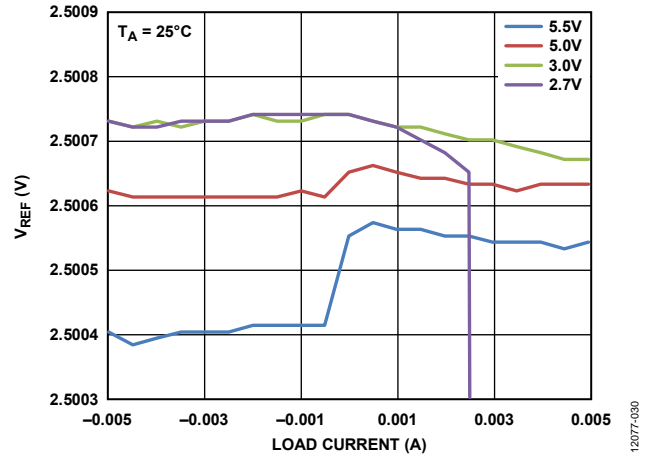

Figure 30. Internal Reference Voltage vs. Load Current

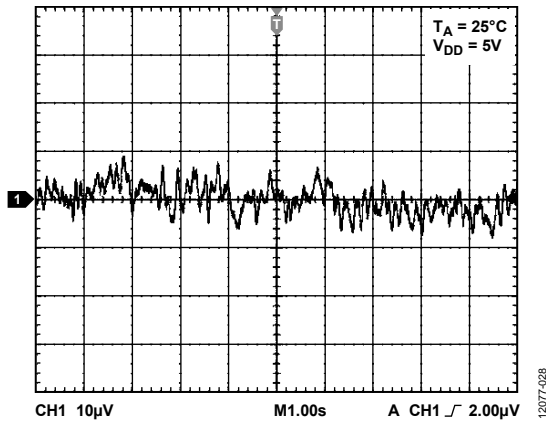

Figure 28. Internal Reference Noise, 0.1 Hz to 10 Hz

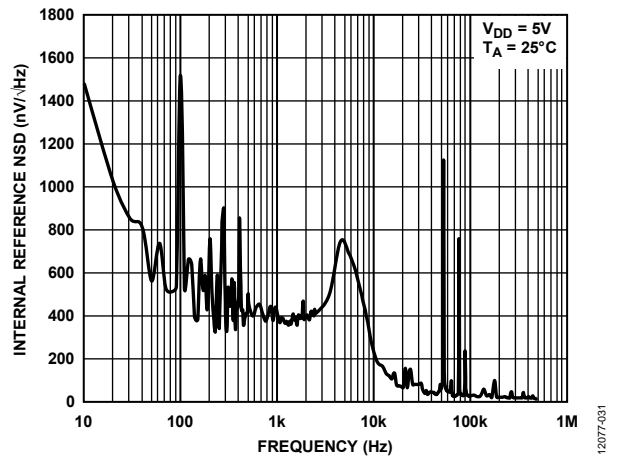

Figure 31. Internal Reference Noise Spectral Density vs. Frequency

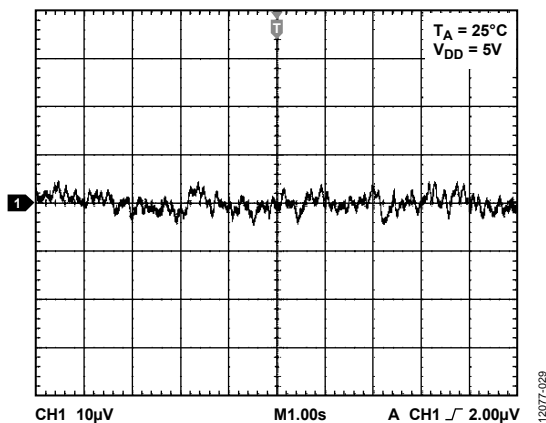

Figure 29. 0.1 Hz to 10 Hz Output Noise Plot, Internal Reference On

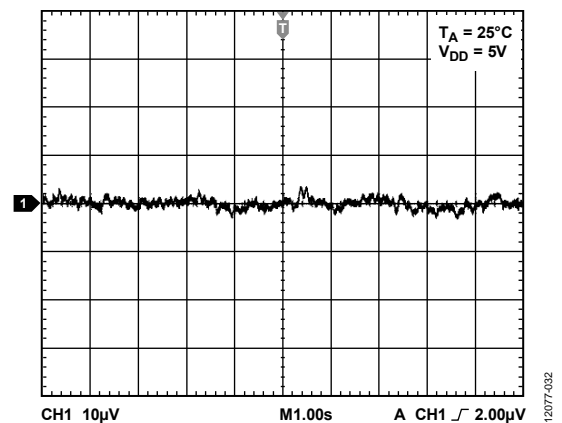

Figure 32. 0.1 Hz to 10 Hz Output Noise Plot, External Reference

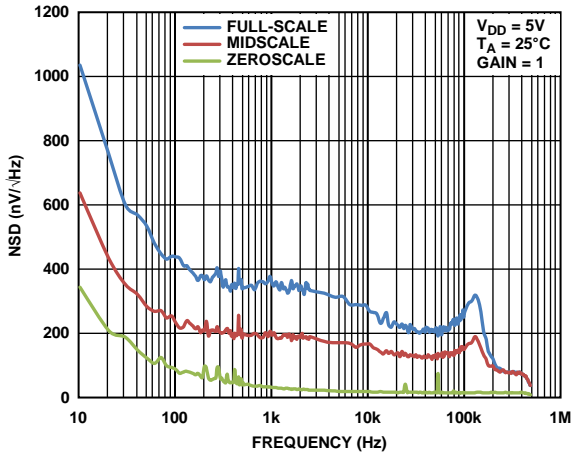

Figure 33. Noise Spectral Density vs. Frequency, Gain = 1

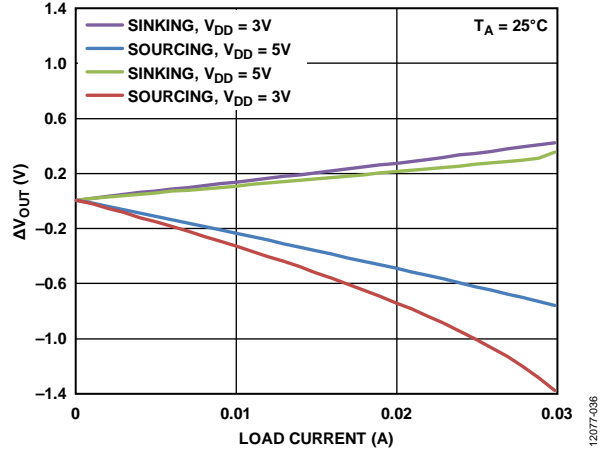

Figure 36. Headroom/Footroom vs. Load Current

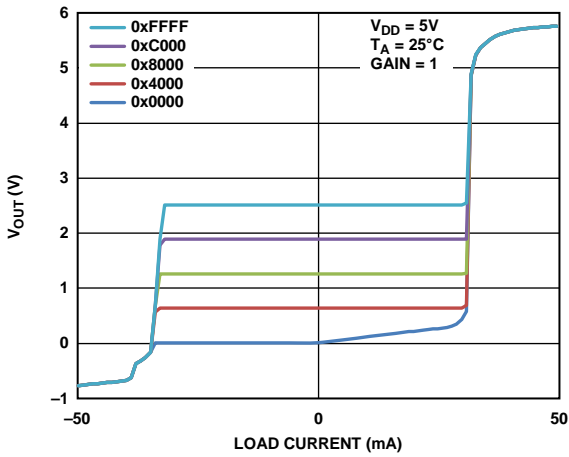

Figure 34. Source and Sink Capability, Gain = 1

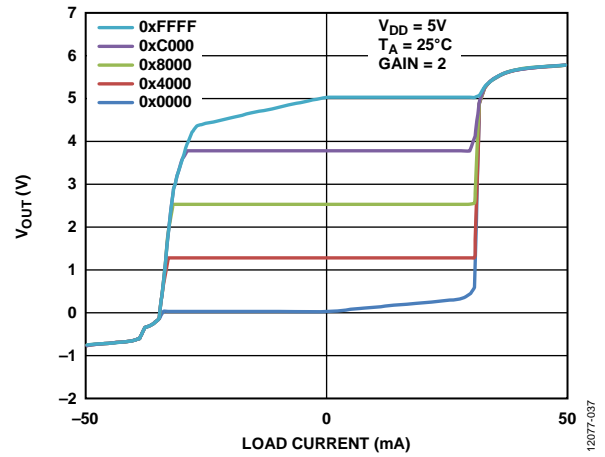

Figure 37. Source and Sink Capability, Gain = 2

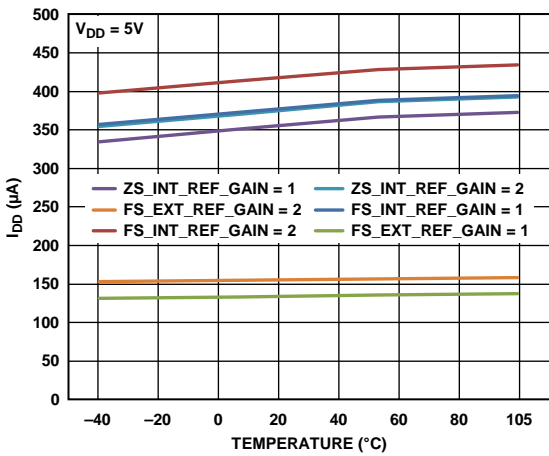

Figure 35. I_{DD} vs. Temperature

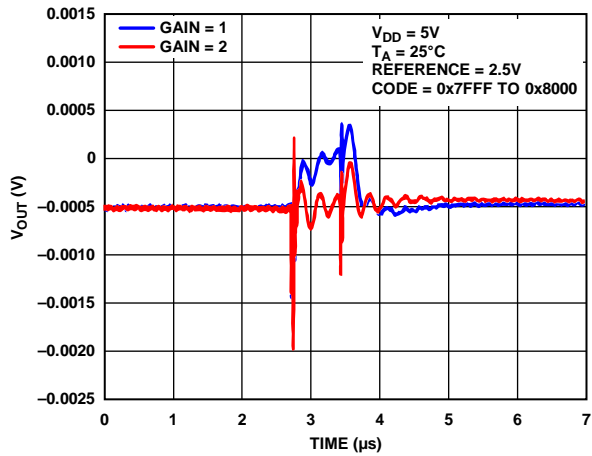

Figure 38. Digital-to-Analog Glitch Impulse

12077-033

12077-036

12077-034

12077-037

12077-035

12077-038

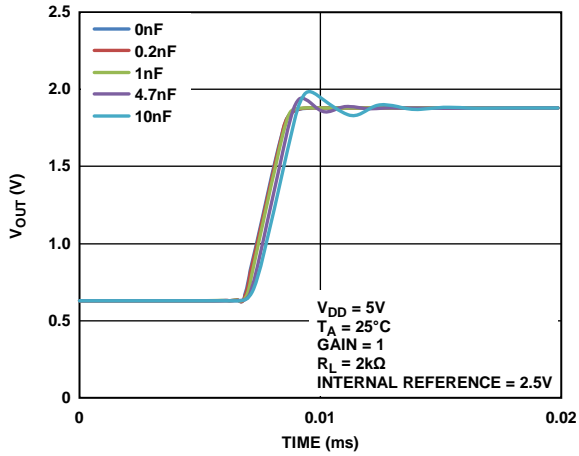

Figure 39. Capacitive Load vs. Settling Time, Gain = 1

12077-039

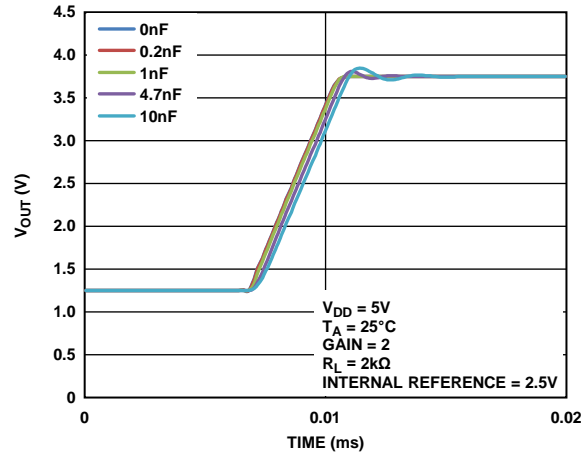

Figure 42. Capacitive Load vs. Settling Time, Gain = 2

12077-042

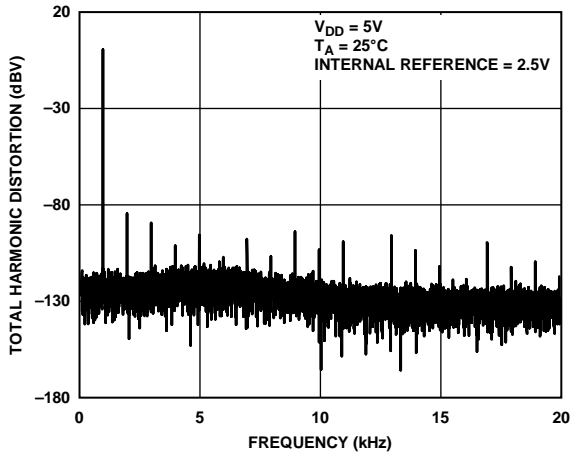

Figure 40. Total Harmonic Distortion at 1 kHz

12077-040

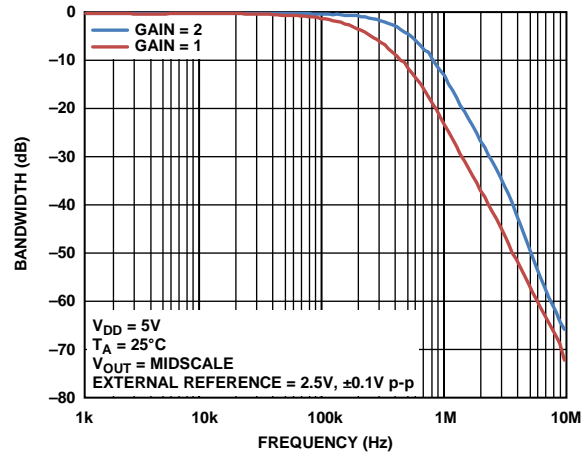

Figure 43. Multiplying Bandwidth, External Reference = 2.5 V, ± 0.1 V p-p, 10 kHz to 10 MHz

12077-043

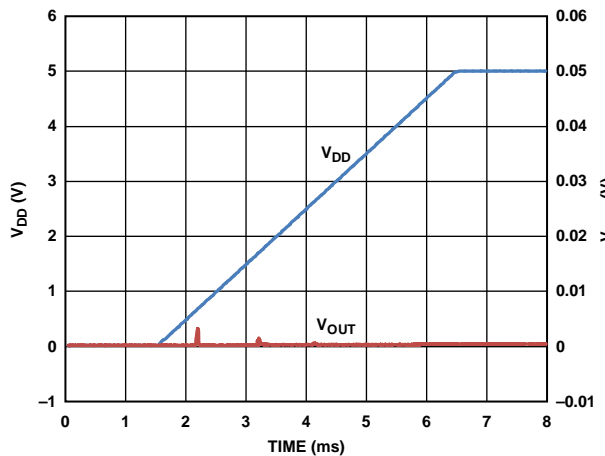

Figure 41. Power-On Reset to 0V

12077-041

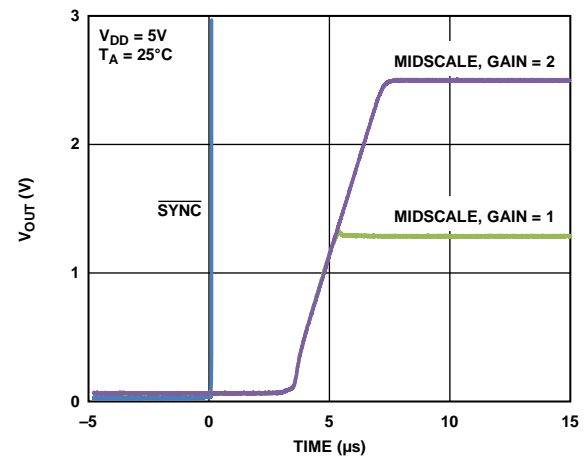

Figure 44. Exiting Power-Down to Midscale

12077-044

TERMINOLOGY

Relative Accuracy or Integral Nonlinearity (INL)

For the DAC, relative accuracy or integral nonlinearity is a measurement of the maximum deviation, in LSBs, from a straight line passing through the endpoints of the DAC transfer function. For typical INL vs. code plots, see Figure 9, Figure 10, and Figure 11.

Differential Nonlinearity (DNL)

Differential nonlinearity is the difference between the measured change and the ideal 1 LSB change between any two adjacent codes. A specified differential nonlinearity of ± 1 LSB maximum ensures monotonicity. This DAC is guaranteed monotonic by design. For typical DNL vs. code plots, see Figure 12, Figure 13, and Figure 14.

Zero Code Error

Zero code error is a measurement of the output error when zero code (0x0000) is loaded to the DAC register. Ideally, the output is 0 V. The zero code error is always positive in the [AD5693R/AD5692R/AD5691R/AD5693](#) because the output of the DAC cannot go below 0 V due to a combination of the offset errors in the DAC and the output amplifier. Zero code error is expressed in mV. For plots of zero code error, see in Figure 22 and Figure 25.

Full-Scale Error

Full-scale error is a measurement of the output error when full-scale code (0xFFFF) is loaded to the DAC register. Ideally, the output should be $V_{DD} - 1$ LSB. Full-scale error is expressed in percent of full-scale range. For plots of full-scale error vs. temperature, see Figure 21 and Figure 24.

Gain Error

Gain error is a measure of the span error of the DAC. It is the deviation in slope of the DAC transfer characteristic from the ideal expressed as % of FSR.

Zero Code Error Drift

Zero code error drift is a measurement of the change in zero code error with a change in temperature. It is expressed in $\mu\text{V}/^\circ\text{C}$.

Gain Temperature Coefficient

Gain temperature coefficient is a measurement of the change in gain error with changes in temperature. It is expressed in ppm of FSR/ $^\circ\text{C}$.

Offset Error

Offset error is a measure of the difference between V_{OUT} (actual) and V_{OUT} (ideal) expressed in mV in the linear region of the transfer function. Offset error is measured on the [AD5693R](#) with Code 512 loaded in the DAC register (Code 256 for the [AD5692R](#) and Code 128 for the [AD5693R/AD5693](#)). It can be negative or positive.

DC Power Supply Rejection Ratio (PSRR)

PSRR indicates how the output of the DAC is affected by changes in the supply voltage. PSRR is the ratio of the change in V_{OUT} to a change in V_{DD} for full-scale output of the DAC. It is measured in mV/V. V_{REF} is held at 2 V, and V_{DD} is varied by $\pm 10\%$.

Output Voltage Settling Time

This is the amount of time it takes for the output of a DAC to settle to a specified level for a $\frac{1}{4}$ to $\frac{3}{4}$ full-scale input change.

Digital-to-Analog Glitch Impulse

Digital-to-analog glitch impulse is the impulse injected into the analog output when the input code in the DAC register changes state. It is normally specified as the area of the glitch in nV-sec, and is measured when the digital input code is changed by 1 LSB at the major carry transition (0x7FFF to 0x8000)

Digital Feedthrough

Digital feedthrough is a measure of the impulse injected into the analog output of the DAC from the digital inputs of the DAC, but is measured when the DAC output is not updated. It is specified in nV-sec, and measured with a full-scale code change on the data bus, that is, from all 0s to all 1s and vice versa.

Noise Spectral Density

Noise spectral density is a measurement of the internally generated random noise. Random noise is characterized as a spectral density ($\text{nV}/\sqrt{\text{Hz}}$). It is measured by loading the DAC to midscale and measuring noise at the output. It is measured in $\text{nV}/\sqrt{\text{Hz}}$. For plots of noise spectral density, see Figure 29, Figure 32, and Figure 33. The noise spectral density for the reference is shown in Figure 28 and Figure 31.

Multiplying Bandwidth

The amplifiers within the DAC have a finite bandwidth. The multiplying bandwidth is a measure of these finite bandwidths. A sine wave on the reference (with full-scale code loaded to the DAC) appears on the output. The multiplying bandwidth is the frequency at which the output amplitude falls to 3 dB below the input.

Total Harmonic Distortion (THD)

THD is the difference between an ideal sine wave and its attenuated version using the DAC. The sine wave is used as the reference for the DAC, and THD is a measurement of the harmonics present on the DAC output. It is measured in dB.

Voltage Reference Temperature Coefficient (TC)

Voltage reference TC is a measure of the change in the reference output voltage with a change in temperature. The reference TC is calculated using the box method, which defines the TC as the maximum change in the reference output over a given temperature range expressed in ppm/ $^\circ\text{C}$ as follows:

$$TC = \left[\frac{V_{REFmax} - V_{REFmin}}{V_{REFnom} \times TempRange} \right] \times 10^6$$

where:

V_{REFmax} is the maximum reference output measured over the total temperature range.

V_{REFmin} is the minimum reference output measured over the total temperature range.

V_{REFnom} is the nominal reference output voltage, 2.5 V.

$TempRange$ is the specified temperature range, -40°C to $+105^\circ\text{C}$.

THEORY OF OPERATION

DIGITAL-TO-ANALOG CONVERTER

The AD5693R/AD5692R/AD5691R/AD5693 are single 16-bit, 14-bit, and 12-bit, serial input, voltage output DACs with a 2.5 V internal reference. The devices operate from supply voltages of 2.7 V to 5.5 V. Data is written to the AD5693R/AD5692R/AD5691R/AD5693 in a 24-bit word format via an I²C serial interface.

The AD5693R/AD5692R/AD5691R/AD5693 incorporate a power-on reset circuit that ensures that the DAC output powers up to zero scale. The devices also have a software power-down mode that reduces the current consumption to 2 μA maximum.

TRANSFER FUNCTION

The internal reference is on by default. The input coding to the DAC is straight binary. The ideal output voltage is given by the following equations:

For the AD5693R/AD5693,

$$V_{OUT}(D) = Gain \times V_{REF} \times \left[\frac{D}{65,536} \right]$$

For the AD5692R,

$$V_{OUT}(D) = Gain \times V_{REF} \times \left[\frac{D}{16,384} \right]$$

For the AD5691R,

$$V_{OUT}(D) = Gain \times V_{REF} \times \left[\frac{D}{4096} \right]$$

where:

D is the decimal equivalent of the binary code that is loaded to the DAC register.

$Gain$ is the gain of the output amplifier and it is set to $\times 1$ by default. The gain can also be set to $\times 2$ using the gain bit in the control register.

DAC ARCHITECTURE

The AD5693R/AD5692R/AD5691R/AD5693 implement a segmented string DAC architecture with an internal output buffer. Figure 45 shows the internal block diagram.

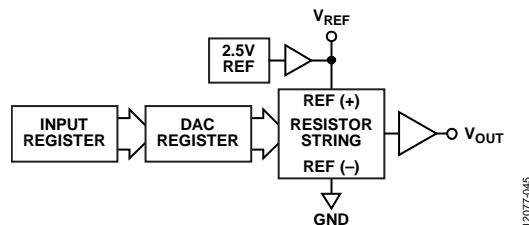

Figure 45. DAC Channel Architecture Block Diagram

The simplified segmented resistor string DAC structure is shown in Figure 46. The code loaded to the DAC register determines the switch on the string that is connected to the output buffer.

Because each resistance in the string has same value, R , the string DAC is guaranteed monotonic.

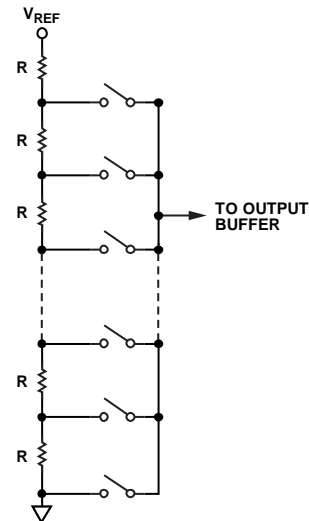

Figure 46. Simplified Resistor String Structure

Internal Reference

The AD5693R/AD5692R/AD5691R on-chip reference is on at power-up but can be disabled via a write to the control register.

The AD5693R/AD5692R/AD5691R each have a 2.5 V, 2 ppm/°C reference, giving a full-scale output of 2.5 V or 5 V, depending on the state of the gain bit.

The internal reference is available at the V_{REF} pin. It is internally buffered and capable of driving external loads of up to 5 mA.

External Reference

The V_{REF} pin is an input pin in the AD5693. The V_{REF} pin can also be configured as an input pin on the AD5693R/AD5692R/AD5691R, allowing the use of an external reference if the application requires it.

In the AD5693R/AD5692R/AD5691R, the default condition of the on-chip reference is on at power-up. Before connecting an external reference to the pin, disable the internal reference by writing to the REF bit (Bit DB12) in the control register.

Output Buffer

The output buffer is designed as an input/output rail-to-rail buffer, which gives a maximum output voltage range of up to V_{DD} . The gain bit sets the segmented string DAC gain to $\times 1$ or $\times 2$, as shown in Table 14.

The output buffer voltage is determined by V_{REF} , the gain bit, and the offset and gain errors.

The output buffer can drive a 10 nF capacitance with a 2 kΩ resistor in parallel, as shown in Figure 39 and Figure 42. If a higher capacitance load is required, use the snubber method or a shunt resistor to isolate the load from the output amplifier. The slew rate is 0.7 V/μs with a $\frac{1}{4}$ to $\frac{3}{4}$ scale settling time of 5 μs.

SERIAL INTERFACE

The [AD5693R/AD5692R/AD5691R/AD5693](#) have 2-wire, I²C-compatible serial interfaces. These devices can be connected to an I²C bus as a slave device, under the control of a master device. See Figure 3 for a timing diagram of a typical write sequence.

The [AD5693R/AD5692R/AD5691R/AD5693](#) support standard (100 kHz) and fast (400 kHz) data transfer modes. Support is not provided for 10-bit addressing and general call addressing.

I²C SERIAL DATA INTERFACE

The 2-wire serial bus protocol operates as follows:

1. The master initiates data transfer by establishing a start condition when a high-to-low transition on the SDA line occurs while SCL is high. The following byte is the address byte, which consists of the 7-bit slave address. The slave address corresponding to the transmitted address responds by pulling SDA low during the 9th clock pulse (this is called the acknowledge (ACK) bit). At this stage, all other devices on the bus remain idle while the selected device waits for data to be written to, or read from, its shift register.
2. Data is transmitted over the serial bus in sequences of nine clock pulses (eight data bits followed by an acknowledge bit). The transitions on the SDA line must occur during the low period of SCL and remain stable during the high period of SCL.
3. When all data bits have been read or written, a stop condition is established. In write mode, the master pulls the SDA line high during the 10th clock pulse to establish a stop condition. In read mode, the master issues a no acknowledge for the ninth clock pulse (that is, the SDA line remains high). The master then brings the SDA line low before the 10th clock pulse, and then high during the 10th clock pulse to establish a stop condition.

I²C ADDRESS

The [AD5693R/AD5692R/AD5691R/AD5693](#) have a 7-bit slave address. The five MSBs are 10011. The second last bit set by the state of the A0 address pin and the LSB is 0. The ability to make hardwired changes to A0 lets the user have two of these devices on one bus, as outlined in Table 11. Additionally, the pin can be updated before starting the transmission, allowing multiple devices in the same bus by connecting the pin to a GPIO or a multiplexer.

Table 11. Device Address Selection

A0 Pin Connection	A0	I ² C Address
GND	0	1001100
V _{LOGIC} (V _{DD} on LFCSP Package)	1	1001110

WRITE OPERATION

When writing to the [AD5693R/AD5692R/AD5691R/AD5693](#), the user must begin with a start condition followed by an address byte (R/W = 0), after which the DAC acknowledges that it is prepared to receive data by pulling SDA low, as shown in Figure 47. The [AD5693R/AD5692R/AD5691R/AD5693](#) require a command byte that controls various DAC functions (see Table 12) and two bytes of data for the DAC. All these data bytes are acknowledged by the [AD5693R/AD5692R/AD5691R/AD5693](#). A stop condition follows. The write sequence is shown in Figure 47.

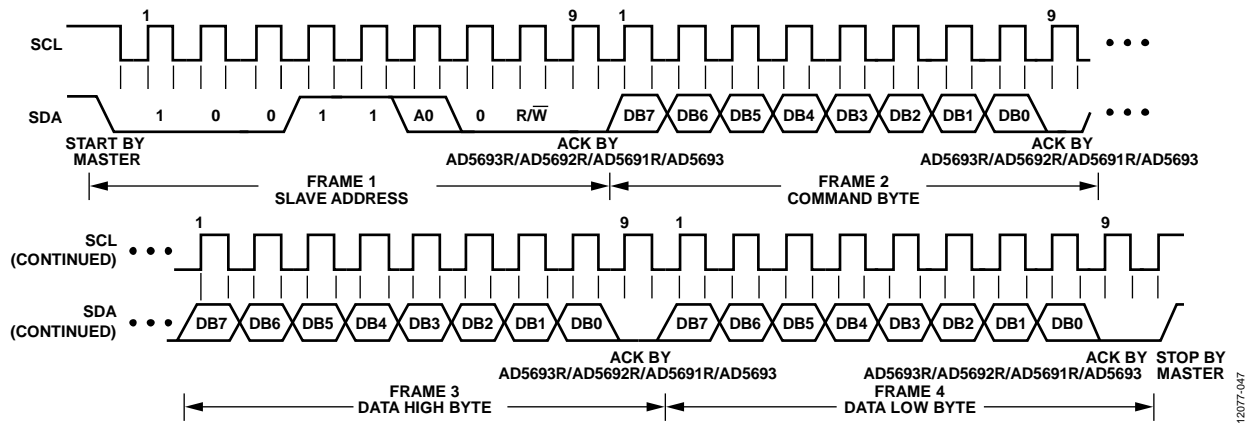

Figure 47. I²C Write Operation

Table 12. Command Table¹

Command Byte					Data High Byte		Data Low Byte				Operation	
DB7	DB6	DB5	DB4	[DB3:DB0]	[DB7:DB3]	[DB2:DB0]	[DB7:DB4]	DB3	DB2	DB1		DB0
0	0	0	0	XXXX	XXXXX	XXX	XXXX	X	X	X		NOP: do nothing.
0	0	0	1	XXXX	DB15:DB11	DB10:DB8	DB7:DB4	DB3 ²	DB2 ²	DB1 ^{2,3}	DB0 ^{2,3}	Write input register.
0	0	1	0	XXXX	XXXXX	XXX	XXXX	X	X	X	X	Update DAC register (LDAC software).
0	0	1	1	XXXX	DB15:DB11	DB10:DB8	DB7:DB4	DB3 ²	DB2 ²	DB1 ^{2,3}	DB0 ^{2,3}	Write DAC and input registers.
0	1	0	0	XXXX	DB15:DB11	000	0000	0	0	0	0	Write control register.

¹ X is don't care.

² This bit is a don't care for the AD5691R.

³ This bit is a don't care for the AD5692R.

Write Input Register

The input register allows the preloading of a new value for the DAC register. The transfer from the input register to the DAC register can be triggered by hardware, the LDAC pin, or by software using Command 2.

If new data is loaded into the DAC register, the DAC register automatically overwrites the input register.

Update DAC Register

This command transfers the contents of the input register to the DAC register and, consequently, the V_{OUT} pin is updated. The data contained in the serial write is ignored.

This operation is equivalent to a software LDAC.

Write DAC Register

This command updates the DAC output on completion of the write operation. The input register is refreshed automatically with the DAC register value.

Write Control Register

The control register is used to set the power-down and gain functions. It is also used to enable/disable the internal reference and perform a software reset. See Table 13 for the control register functionality.

Table 13. Control Register Bits

D15	D14	D13	D12	D11
Reset	PD1	PD0	REF	Gain

Gain Bit

The gain bit selects the gain of the output amplifier. Table 14 shows how the output voltage range corresponds to the state of the gain bit.

Table 14. Gain Bit

Gain	Output Voltage Range
0	0 V to V _{REF} (default)
1	0 V to 2 × V _{REF}

REF Bit

In the AD5693R/AD5692R/AD5691R only, the on-chip reference is on at power-up by default. This reference can be turned on or off by setting a software programmable bit, DB12, in the control register. Table 15 shows how the state of the bit corresponds to the mode of operation.

To reduce the power consumption, it is recommended to disable the internal reference if the device is placed in power-down mode.

Table 15. Reference Bit

REF	Reference Function
0	Reference enabled (default)
1	Reference disabled

PD0 and PD1 Bits

The AD5693R/AD5692R/AD5691R/AD5693 contain two separate modes of operation that are accessed by writing to the control register.

In normal mode, the output buffer is directly connected to the V_{OUT} pin.

In power-down mode, the output buffer is internally disabled and the V_{OUT} pin output impedance can be selected to a well known value, as shown in Table 16.

Table 16. Operation Modes

Operating Mode	PD1	PD0
Normal Mode	0	0
Power-Down Modes		
1 kΩ Output Impedance	0	1
100 kΩ Output Impedance	1	0
Three-State Output Impedance	1	1

In power-down mode, the device disables the output buffer but does not disable the internal reference. To achieve maximum power savings, it is recommended to disable the internal reference.

Disabling both the internal reference and the output buffer results in the supply current falling to 2 μ A at 5 V.

The output stage is shown in Figure 48.

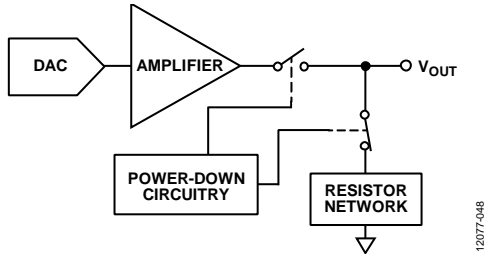

Figure 48. Output Stage During Power-Down

The output amplifier is shut down when the power-down mode is activated. However, unless the internal reference is powered down (using Bit DB12 in the control register), the bias generator, reference, and resistor string remain on. The supply current falls to 2 μ A at 5 V. The contents of the DAC register are unaffected when in power-down mode, and the DAC register can continue to be updated. The time that is required to exit power-down is typically 4 μ s for $V_{DD} = 5$ V, or 600 μ s if the reference is disabled.

Reset Bit

The AD5693R/AD5692R/AD5691R/AD5693 control register contains a software reset bit that resets the DAC to zero-scale and resets the input, DAC, and control registers to their default values. A software reset is initiated by setting the RESET bit in the control register to 1. When the software reset has completed, the reset bit is cleared to 0 automatically.

READ OPERATION

When reading the input register back from the AD5693R/AD5692R/AD5691R/AD5693 DACs, the user begins with an address byte ($R/\overline{W} = 1$), after which the DAC acknowledges that it is prepared to receive data by pulling SDA low. Two bytes of data containing the contents of the input register are then read from the DAC, as shown in Figure 49. A NACK condition from the master followed by a STOP condition completes the read sequence.

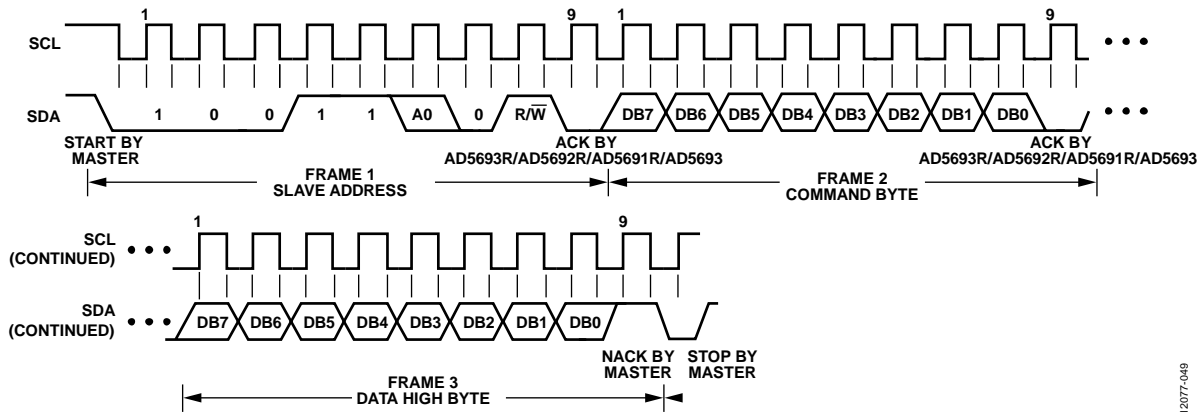

Figure 49. I²C Read Operation

LOAD DAC (HARDWARE $\overline{\text{LDAC}}$ PIN)

The AD5693R/AD5692R/AD5691R/AD5693 DAC has a double buffered interface consisting of an input register and a DAC register. The $\overline{\text{LDAC}}$ pin transfers data from the input register to the DAC register, and the output is updated.

Synchronous DAC Update

If the $\overline{\text{LDAC}}$ pin is held low while the input register is written, the DAC register, input register, and output are updated on the last SCL falling edge before the ACK bit, as shown in Figure 4.

Asynchronous DAC Update

$\overline{\text{LDAC}}$ is held high while data is transmitted to the device. The DAC output is updated by taking $\overline{\text{LDAC}}$ low after the stop condition has been generated. The output DAC is updated on the falling edge of the $\overline{\text{LDAC}}$ pin. If $\overline{\text{LDAC}}$ is pulsed while the device is accessed, the pulse is ignored.

HARDWARE $\overline{\text{RESET}}$

$\overline{\text{RESET}}$ is an active low signal that resets the DAC output to zero-scale and sets the input, DAC, and control registers to their default values. It is necessary to keep $\overline{\text{RESET}}$ low for 75 ns to complete the operation. When the $\overline{\text{RESET}}$ signal is returned high, the output remains at zero scale until a new value is programmed. While the $\overline{\text{RESET}}$ pin is low, the AD5693R/AD5692R/AD5691R/AD5693 ignore any new command. If the $\overline{\text{RESET}}$ pin is held low at power-up, the internal reference is not initialized correctly until the $\overline{\text{RESET}}$ pin is released.

THERMAL HYSTERESIS

Thermal hysteresis is the voltage difference induced on the reference voltage by sweeping the temperature from ambient to cold, to hot, and then back to ambient.

The thermal hysteresis data is shown in Figure 50. It is measured by sweeping the temperature from ambient to -40°C , then to $+105^{\circ}\text{C}$, and finally returning to ambient. The V_{REF} delta is measured between the two ambient measurements; the result is shown in solid lines in Figure 50. The same temperature sweep and measurements were immediately repeated; the results are shown in dashed lines in Figure 50.

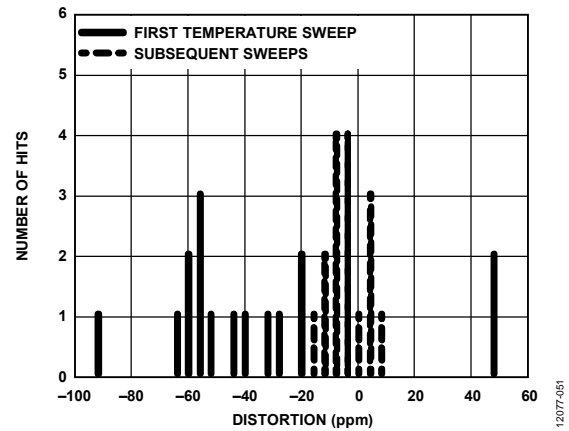

Figure 50. Thermal Hysteresis

POWER-UP SEQUENCE

Because diodes limit the voltage compliance at the digital pins and analog pins, it is important to power GND first before applying any voltage to V_{DD} , V_{OUT} , and V_{LOGIC} . Otherwise, the diode is forward-biased such that V_{DD} is powered unintentionally. The ideal power-up sequence is GND, V_{DD} , V_{LOGIC} , V_{REF} , followed by the digital inputs.

RECOMMENDED REGULATOR

The [AD5693R/AD5692R/AD5691R/AD5693](#) use a 5 V (V_{DD}) supply as well as a digital logic supply (V_{LOGIC}).

The analog and digital supplies required for the [AD5693R/AD5692R/AD5691R/AD5693](#) can be generated using Analog Devices, Inc., low dropout (LDO) regulators such as the [ADP7118](#) and the [ADP162](#), respectively, for analog and digital supplies.

LAYOUT GUIDELINES

In any circuit where accuracy is important, careful consideration of the power supply and ground return layout helps to ensure the rated performance. Design the printed circuit board (PCB) on which the ADCs are mounted such that the [AD5693R/AD5692R/AD5691R/AD5693](#) lie on the analog plane.

Ensure that the [AD5693R/AD5692R/AD5691R/AD5693](#) have ample supply bypassing of 10 μF , in parallel with a 0.1 μF capacitor on each supply that is located as near the package as possible (ideally, right up against the device). The 10 μF capacitors are of the tantalum bead type. Ensure that the 0.1 μF capacitor has low effective series resistance (ESR) and low effective series inductance (ESI), such as the common ceramic types, which provide a low impedance path to ground at high frequencies to handle transient currents due to internal logic switching.

In systems where many devices are on one board, it is often useful to provide some heat sinking capability to allow the power to dissipate easily.

The LFCSP package of the [AD5693R/AD5692R/AD5691R/AD5693](#) has an exposed pad beneath the device. Connect this pad to the GND supply of the device. For optimum performance, use special consideration when designing the motherboard and mounting the package. For enhanced thermal, electrical, and board level performance, solder the exposed pad on the bottom of the package to the corresponding thermal land pad on the PCB. Design thermal vias into the PCB land pad area to further improve heat dissipation.

The GND plane on the device can be increased (as shown in Figure 51) to provide a natural heat sinking effect.

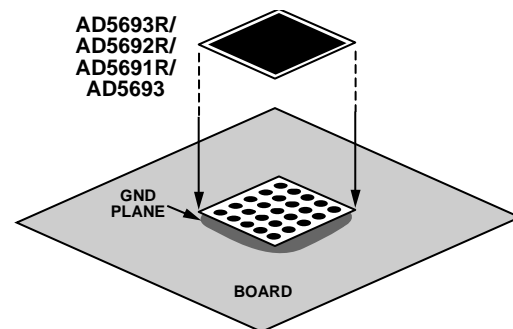
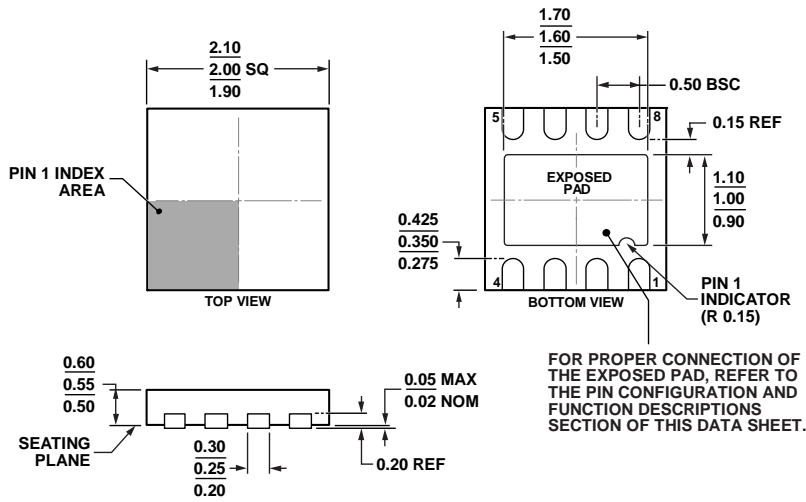

Figure 51. Pad Connection to Board

12077-052

OUTLINE DIMENSIONS



01-14-2013C

Figure 52. 8-Lead Lead Frame Chip Scale Package [LFCSP_UD]
 2.00 mm × 2.00 mm Body, Ultra Thin, Dual Lead
 (CP-8-10)
 Dimensions shown in millimeters

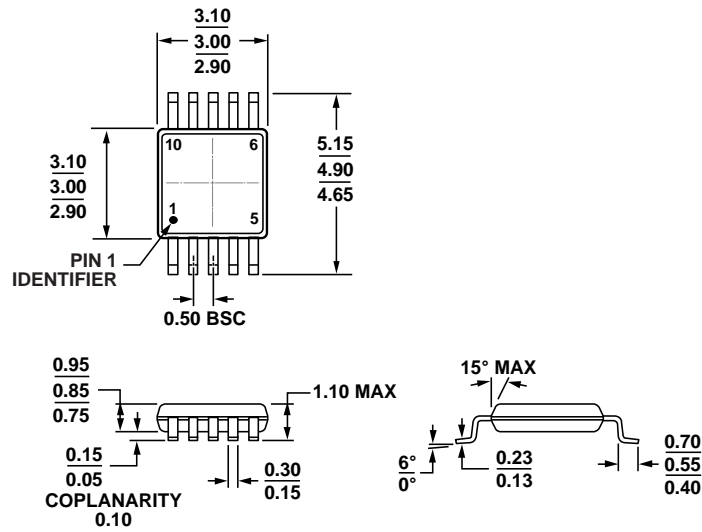

081705-A

COMPLIANT TO JEDEC STANDARDS MO-187-BA

Figure 53. 10-Lead Mini Small Outline Package [MSOP]
 (RM-10)
 Dimensions shown in millimeters

ORDERING GUIDE

Model ¹	Resolution (Bits)	Pinout	Temperature Range	Performance	Package Description	Package Option	Branding
AD5693RACPZ-RL7	16	$\overline{\text{LDAC}}$	-40°C to +105°C	A Grade	8-Lead LFCSP_UD	CP-8-10	AB
AD5693RACPZ-1RL7	16	V _{LOGIC}	-40°C to +105°C	A Grade	8-Lead LFCSP_UD	CP-8-10	AC
AD5693RARMZ	16		-40°C to +105°C	A Grade	10-Lead MSOP	RM-10	DJU
AD5693RARMZ-RL7	16		-40°C to +105°C	A Grade	10-Lead MSOP	RM-10	DJU
AD5693RBCPZ-2RL7	16	$\overline{\text{RESET}}$	-40°C to +105°C	B Grade	8-Lead LFCSP_UD	CP-8-10	AD
AD5693RBRMZ	16		-40°C to +105°C	B Grade	10-Lead MSOP	RM-10	DJV
AD5693RBRMZ-RL7	16		-40°C to +105°C	B Grade	10-Lead MSOP	RM-10	DJV
AD5693BCPZ-RL7	16	$\overline{\text{LDAC}}$	-40°C to +105°C	B Grade	8-Lead LFCSP_UD	CP-8-10	AA
AD5692RACPZ-RL7	14	$\overline{\text{LDAC}}$	-40°C to +105°C	A Grade	8-Lead LFCSP_UD	CP-8-10	4M
AD5691RACPZ-1RL7	12	V _{LOGIC}	-40°C to +105°C	A Grade	8-Lead LFCSP_UD	CP-8-10	5W
AD5691RBCPZ-RL7	12	$\overline{\text{LDAC}}$	-40°C to +105°C	B Grade	8-Lead LFCSP_UD	CP-8-10	6M
AD5691RBRMZ	12		-40°C to +105°C	B Grade	10-Lead MSOP	RM-10	DK2
AD5691RBRMZ-RL7	12		-40°C to +105°C	B Grade	10-Lead MSOP	RM-10	DK2
EVAL-AD5693RSDZ					Evaluation Board		

¹ Z = RoHS Compliant Part.

¹²C refers to a communications protocol originally developed by Philips Semiconductors (now NXP Semiconductors).