



**LR Series  
Receiver Module  
Data Guide**

**Wireless made simple<sup>®</sup>**

**Warning:** Some customers may want Linx radio frequency (“RF”) products to control machinery or devices remotely, including machinery or devices that can cause death, bodily injuries, and/or property damage if improperly or inadvertently triggered, particularly in industrial settings or other applications implicating life-safety concerns (“Life and Property Safety Situations”).

**NO OEM LINX REMOTE CONTROL OR FUNCTION MODULE SHOULD EVER BE USED IN LIFE AND PROPERTY SAFETY SITUATIONS.** No OEM Linx Remote Control or Function Module should be modified for Life and Property Safety Situations. Such modification cannot provide sufficient safety and will void the product’s regulatory certification and warranty.

Customers may use our (non-Function) Modules, Antenna and Connectors as part of other systems in Life Safety Situations, but only with necessary and industry appropriate redundancies and in compliance with applicable safety standards, including without limitation, ANSI and NFPA standards. It is solely the responsibility of any Linx customer who uses one or more of these products to incorporate appropriate redundancies and safety standards for the Life and Property Safety Situation application.

**Do not use this or any Linx product to trigger an action directly from the data line or RSSI lines without a protocol or encoder/decoder to validate the data.** Without validation, any signal from another unrelated transmitter in the environment received by the module could inadvertently trigger the action.

**All RF products are susceptible to RF interference that can prevent communication.** RF products without frequency agility or hopping implemented are more subject to interference. This module does not have a frequency hopping protocol built in.

**Do not use any Linx product over the limits in this data guide.** Excessive voltage or extended operation at the maximum voltage could cause product failure. Exceeding the reflow temperature profile could cause product failure which is not immediately evident.

**Do not make any physical or electrical modifications to any Linx product.** This will void the warranty and regulatory and UL certifications and may cause product failure which is not immediately evident.

# Table of Contents

1	<a href="#">Description</a>
1	<a href="#">Features</a>
1	<a href="#">Applications</a>
2	<a href="#">Ordering Information</a>
2	<a href="#">Absolute Maximum Ratings</a>
3	<a href="#">Electrical Specifications</a>
5	<a href="#">Typical Performance Graphs</a>
7	<a href="#">Pin Assignments</a>
7	<a href="#">Pin Descriptions</a>
8	<a href="#">Module Description</a>
9	<a href="#">Theory of Operation</a>
10	<a href="#">Using the RSSI Pin</a>
11	<a href="#">The Data Output</a>
12	<a href="#">Using the PDN Line</a>
13	<a href="#">Power Supply Requirements</a>
13	<a href="#">ESD Concerns</a>
14	<a href="#">Typical Applications</a>
15	<a href="#">Transferring Data</a>
16	<a href="#">Antenna Considerations</a>
17	<a href="#">Helpful Application Notes from Linx</a>
17	<a href="#">Protocol Guidelines</a>
18	<a href="#">Interference Considerations</a>
19	<a href="#">Pad Layout</a>
19	<a href="#">Board Layout Guidelines</a>
21	<a href="#">Microstrip Details</a>
22	<a href="#">Production Guidelines</a>
22	<a href="#">Hand Assembly</a>
22	<a href="#">Automated Assembly</a>
24	<a href="#">General Antenna Rules</a>

## LR Series Receiver Module Data Guide



### Description

The LR Receiver is ideal for the wireless transfer of serial data, control, or command information in the favorable 260 to 470MHz band. The receiver's advanced synthesized architecture achieves an outstanding typical sensitivity of  $-112\text{dBm}$ , which provides a 5 to 10 times improvement in range over previous solutions. When paired with a compatible Linix transmitter, a reliable wireless link is formed

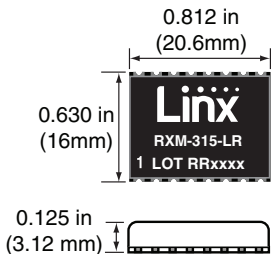

Figure 1: Package Dimensions

capable of transferring serial data at rates of up to 10,000bps at distances of up to 1.5 miles (2,500m). This range may be reduced depending on the regulations in the country of operation. Applications operating over shorter distances or at lower data rates also benefit from increased link reliability and superior noise immunity. Housed in a tiny reflow-compatible SMD package, no external RF components are required (except an antenna), allowing for easy integration, even for engineers without previous RF experience.

### Features

- Long range
- Low cost
- PLL-synthesized architecture
- Direct serial interface
- Data rates up to 10,000bps
- No external RF components required
- Low power consumption
- Low supply voltage (2.1 to 3.6VDC)
- Compact surface-mount package
- Wide temperature range
- RSSI and Power-down function
- No production tuning

### Applications

- Remote control
- Keyless entry
- Garage/gate openers
- Lighting control
- Medical monitoring/call systems
- Remote industrial monitoring
- Periodic data transfer
- Home/industrial automation
- Fire/security alarms
- Remote status/position sensing
- Long-range RFID
- Wire elimination

## Ordering Information

Ordering Information	
Part Number	Description
TXM-315-LR	315MHz Transmitter
TXM-418-LR	418MHz Transmitter
TXM-433-LR	433MHz Transmitter
RXM-315-LR	315MHz Receiver
RXM-418-LR	418MHz Receiver
RXM-433-LR	433MHz Receiver
EVAL-***-LR	LR Series Basic Evaluation Kit

\*\*\* = 315, 418 (Standard), 433MHz  
Receivers are supplied in tubes of 18 pcs.

Figure 2: Ordering Information

## Absolute Maximum Ratings

Absolute Maximum Ratings				
Supply Voltage $V_{CC}$	-0.3	to	+3.6	VDC
Supply Voltage $V_{CC}$ , Using Resistor	-0.3	to	+5.2	VDC
Any Input or Output Pin	-0.3	to	$V_{CC} + 0.3$	VDC
RF Input		0		dBm
Operating Temperature	-40	to	+70	°C
Storage Temperature	-40	to	+85	°C
Soldering Temperature	+260°C for 10 seconds			

Exceeding any of the limits of this section may lead to permanent damage to the device. Furthermore, extended operation at these maximum ratings may reduce the life of this device.

Figure 3: Absolute Maximum Ratings

## Electrical Specifications

LR Series Receiver Specifications						
Parameter	Symbol	Min.	Typ.	Max.	Units	Notes
Power Supply						
Operating Voltage	$V_{CC}$	2.7	3.0	3.6	VDC	
With Dropping Resistor		4.3	5.0	5.2	VDC	1,5
Supply Current	$I_{CC}$	4.0	5.2	7.0	mA	
Power Down Current	$I_{PDN}$	20.0	28.0	35.0	µA	5
Receiver Section						
Receive Frequency Range	$F_C$					
RXM-315-LR			315		MHz	
RXM-418-LR			418		MHz	
RXM-433-LR			433.92		MHz	
Center Frequency Accuracy		-50		+50	kHz	
LO Feedthrough			-80		dBm	2,5
IF Frequency	$F_{IF}$		10.7		MHz	5
Noise Bandwidth	$N_{3dB}$		280		kHz	
Data Rate		100		10,000	bps	
Data Output:						
Logic Low	$V_{OL}$		0.0		VDC	3
Logic High	$V_{OH}$		3.0		VDC	3
Power Down Input:						
Logic Low	$V_{IL}$			0.4	VDC	
Logic High	$V_{IH}$	$V_{CC}-0.4$			VDC	
Receiver Sensitivity		-106	-112	-118	dBm	4
RSSI / Analog						
Dynamic Range			80		dB	5
Analog Bandwidth		50		5,000	Hz	5
Gain			16		mv / dB	5
Voltage with No Carrier			1.5		V	5
Antenna Port						
RF Input Impedance	$R_{IN}$		50		Ω	5
Timing						
Receiver Turn-On Time						
Via $V_{CC}$		3.0	7.0	10.0	ms	5,6
Via PDN		0.04	0.25	0.50	nS	5,6

### LR Series Receiver Specifications Continued

Parameter	Symbol	Min.	Typ.	Max.	Units	Notes
Max. Time Between Transitions			10.0		ms	5

#### Environmental

Operating Temperature Range		-40		+70	°C	5
-----------------------------	--	-----	--	-----	----	---

1. The LR can utilize a 4.3 to 5.2VDC supply provided a 330Ω resistor is placed in series with  $V_{CC}$ .
2. Into a 50Ω load.
3. When operating from a 5V source, it is important to consider that the output will swing to well less than 5 volts as a result of the required dropping resistor. Please verify that the minimum voltage will meet the high threshold requirement of the device to which data is being sent.
4. For BER of  $10^{-5}$  at 1,200bps.
5. Characterized, but not tested.
6. Time to valid data output.

Figure 4: Electrical Specifications

**Warning:** This product incorporates numerous static-sensitive components. Always wear an ESD wrist strap and observe proper ESD handling procedures when working with this device. Failure to observe this precaution may result in module damage or failure.

### Typical Performance Graphs

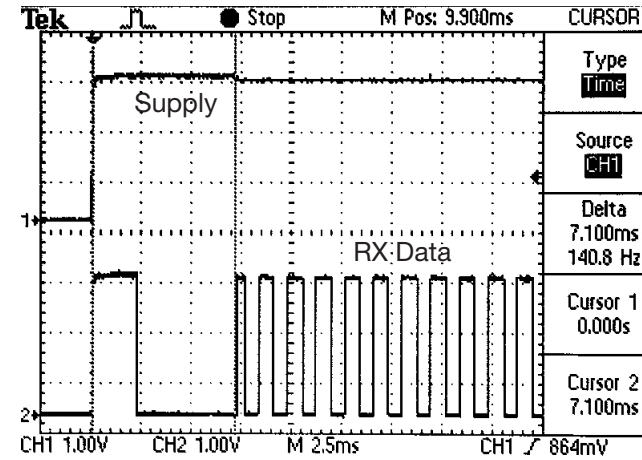

Figure 5: Turn-On Time from  $V_{CC}$

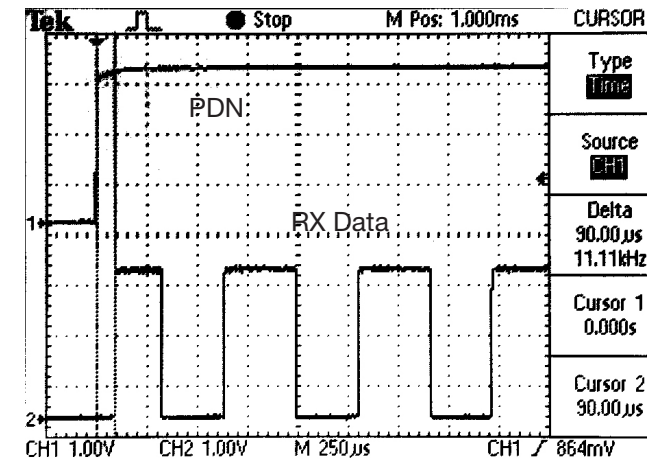

Figure 6: Turn-On Time from PDN

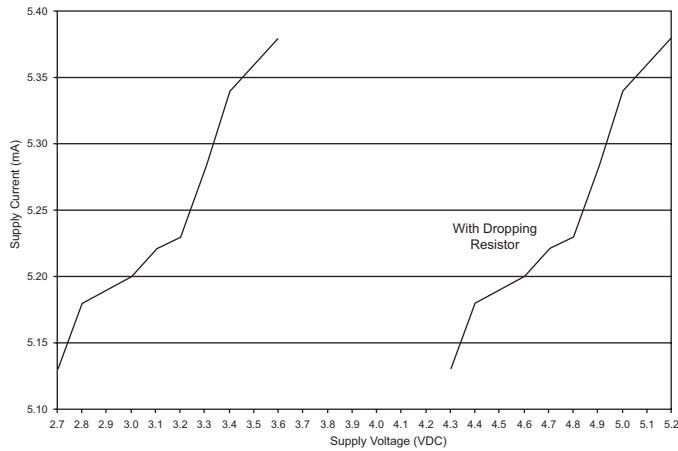

Figure 7: Consumption vs. Supply

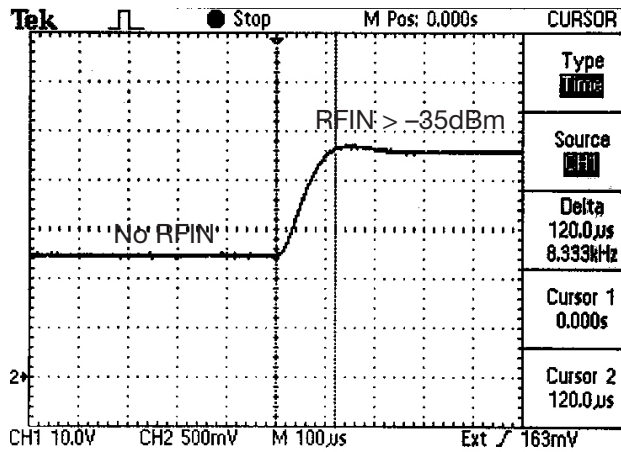

Figure 8: RSSI Response Time

## Pin Assignments

1	NC	ANT	16
2	NC	GND	15
3	NC	NC	14
4	GND	NC	13
5	VCC	NC	12
6	PDN	NC	11
7	RSSI	NC	10
8	DATA	NC	9

Figure 9: LR Series Receiver Pinout (Top View)

## Pin Descriptions

Pin Descriptions			
Pin Number	Name	I/O	Description
1	NC	—	No Connection
2	NC	—	No Connection
3	NC	—	No Connection
4	GND	—	Analog Ground
5	V <sub>cc</sub>	—	Supply Voltage
6	PDN	I	Power Down. Pulling this line low will place the receiver into a low-current state. The module will not be able to receive a signal in this state.
7	RSSI	O	Received Signal Strength Indicator. This line will supply an analog voltage that is proportional to the strength of the received signal.
8	DATA	O	Digital Data Output. This line will output the demodulated digital data.
9	NC	—	No Connection
10	NC	—	No Connection
11	NC	—	No Connection
12	NC	—	No Connection
13	NC	—	No Connection
14	NC	—	No Connection
15	GND	—	Analog Ground
16	RF IN	—	50Ω RF Input

Figure 10: Pin Descriptions

## Module Description

The LR receiver is a low-cost, high-performance synthesized AM / OOK receiver, capable of receiving serial data at up to 10,000bps. Its exceptional sensitivity results in outstanding range performance. The LR's compact surface-mount package is friendly to automated or hand production. LR Series modules are capable of meeting the regulatory requirements of many domestic and international applications.

The receiver's outstanding typical sensitivity of  $-112\text{dBm}$  enables system ranges of up to 1.5 miles (2,500m) when paired with an LR Series transmitter operating at full power and good antennas. Legal regulations in the various countries will require the transmitter output power to be reduced which will reduce range. Following the legal output limit for transmitters in the United States, systems based on the LR Series can achieve ranges of up to 3,000 feet (1,000m).

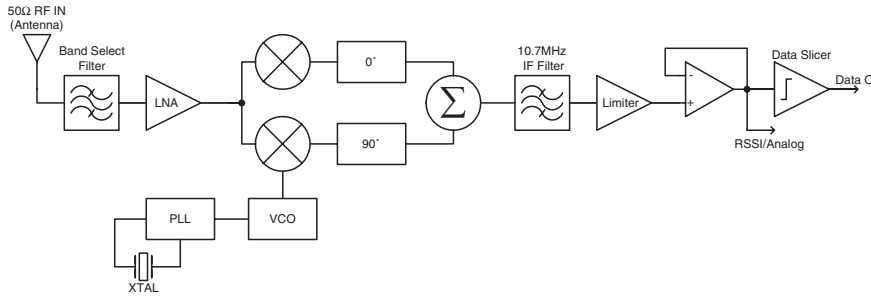

Figure 11: LR Series Receiver Block Diagram

## Theory of Operation

The LR Series receiver is designed to recover data sent by an AM or Carrier-Present Carrier-Absent (CPCA) transmitter, also referred to as CW or On-Off Keying (OOK). This type of modulation represents a logic low '0' by the absence of a carrier



Figure 12: CPCA (AM) Modulation

and a logic high '1' by the presence of a carrier. This modulation method affords numerous benefits. The two most important are: 1) cost-effectiveness due to design simplicity and 2) higher allowable output power and thus greater range in countries (such as the U.S.) that average output power measurements over time. Please refer to Linx Application Note AN-00130 for a further discussion of modulation techniques.

The LR receiver utilizes an advanced single-conversion superheterodyne architecture. Transmitted signals enter the module through a  $50\Omega$  RF port intended for single-ended connection to an external antenna. RF signals entering the antenna are filtered and then amplified by an NMOS cascode Low Noise Amplifier (LNA). The filtered, amplified signal is then down-converted to a 10.7MHz Intermediate Frequency (IF) by mixing it with a low-side Local Oscillator (LO). The LO frequency is generated by a Voltage Controlled Oscillator (VCO) locked by a Phase-Locked Loop (PLL) frequency synthesizer that utilizes a precision crystal reference. The mixer stage incorporates a pair of double-balanced mixers and a unique image rejection circuit. This circuit, along with the high IF frequency and ceramic IF filters, reduces susceptibility to interference. The IF frequency is further amplified, filtered, and demodulated to recover the baseband signal originally transmitted. The baseband signal is squared by a data slicer and output to the DATA pin. The architecture and quality of the components utilized in the LR module enable it to outperform many far more expensive receiver products.

## Using the RSSI Pin

The receiver's Received Signal Strength Indicator (RSSI) line outputs a voltage that is proportional to the incoming signal strength. This line has a dynamic range of 80dB (typical) and can serve a variety of functions. It should be noted that the RSSI levels and dynamic range will vary slightly from part to part. It is also important to remember that RSSI output indicates the strength of any in-band RF energy and not necessarily just that from the intended transmitter; therefore, it should be used only to qualify the level and presence of a signal.

The RSSI output can be utilized during testing or even as a product feature to assess interference and channel quality by looking at the RSSI level with all intended transmitters shut off. The RSSI output can also be used in direction-finding applications, although there are many potential perils to consider in such systems. Finally, it can be used to save system power by "waking up" external circuitry when a transmission is received or crosses a certain threshold. The RSSI output feature adds tremendous versatility for the creative designer.

## The Data Output

The CMOS-compatible data output is normally used to drive a digital decoder IC or a microprocessor that is performing the data decoding. It does not have a large current drive capability so is intended to drive high impedance loads, such as microprocessor inputs or digital logic gates.

The receiver's output may appear to switch randomly in the absence of a transmitter. This is a result of random noise in the environment. This noise can be handled in software by implementing a noise-tolerant protocol as described in Application Note AN-00160. If a software solution is not appropriate, the squelch circuit in Figure 13 can be used. This circuit uses a potentiometer to set a voltage reference. If the RSSI level falls below this reference then a comparator turns off the DATA line and stops the random switching.

This circuit is good for reducing the amount of random noise that the microcontroller must deal with, but it also reduces the sensitivity of the receiver since the received signal level must now be higher. This reduction in sensitivity also reduces the system range. By using a potentiometer the designer can make a compromise between noise level and range.

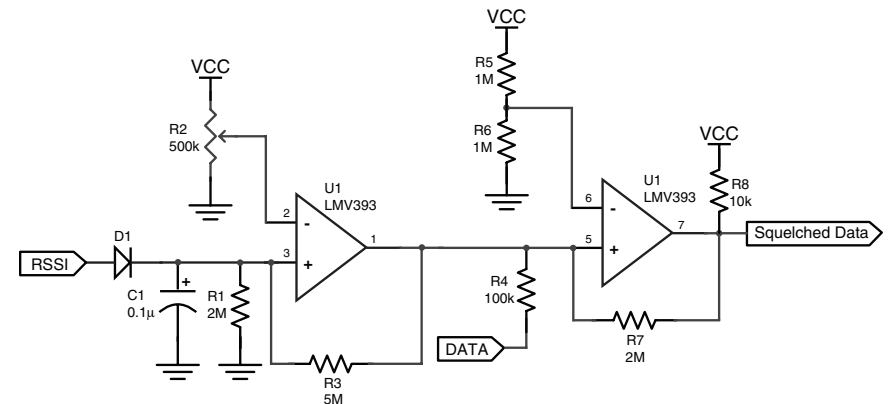

Figure 13: LR Series Receiver Squelch Circuit



## Using the PDN Line

The Power Down (PDN) line can be used to power down the receiver without the need for an external switch. This line has an internal pull-up, so when it is held high or simply left floating, the module is active.

When the PDN line is pulled to ground, the receiver enters a low-current (<40 $\mu$ A) power-down mode. During this time the receiver is off and cannot perform any function. It may be useful to note that the startup time coming out of power-down is slightly less than when applying  $V_{CC}$ .

The PDN line allows easy control of the receiver state from external components, like a microcontroller. By periodically activating the receiver, checking for data, then powering down, the receiver's average current consumption can be greatly reduced, saving power in battery-operated applications.

**Note:** The voltage on the PDN line should not exceed  $V_{CC}$ . When used with a higher voltage source, such as a 5V microcontroller, an open collector line should be used or a diode placed in series with the control line (anode toward the module). Either method avoids damage to the module by preventing 5V from being placed on the PDN line while allowing the line to be pulled low.

## Power Supply Requirements

The module does not have an internal voltage regulator, therefore it requires a clean, well-regulated power source. While it is preferable to power the unit from a battery, it can also be operated from a power supply as long as noise is less than 20mV. Power supply noise can significantly affect the receiver sensitivity, therefore; providing clean power to the module should be a high priority during design.

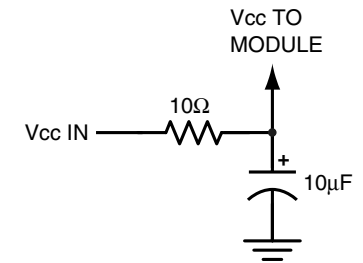

Figure 14: Supply Filter

A 10 $\Omega$  resistor in series with the supply followed by a 10 $\mu$ F tantalum capacitor from  $V_{CC}$  to ground will help in cases where the quality of the supply power is poor. These values may need to be adjusted depending on the noise present on the supply line.

The module can be operated from 4.3V to 5.2V by using an external 330 $\Omega$  series resistor to prevent  $V_{CC}$  from exceeding 3.6V. This resistor can replace the 10 $\Omega$  in the supply filter. While the receiver's current consumption is constant and makes this possible, it is recommended to operate the receiver from a 3.0 to 3.3V supply

## ESD Concerns

The module has basic ESD protection built in, but in cases where the antenna connection is exposed to the user it is a good idea to add additional protection. A Transient Voltage Suppressor (TVS) diode, varistor or similar component can be added to the antenna line. These should have low capacitance and be designed for use on antennas. Protection on the supply line is a good idea in designs that have a user-accessible power port.

## Typical Applications

Figure 15 shows a circuit using the Linx LICAL-DEC-MS001 decoder. This chip works with the LICAL-ENC-MS001 encoder to provide simple remote control capabilities. The decoder detects the transmission from the encoder, checks for errors, and if everything is correct, replicates the encoder's inputs on its outputs. This makes sending key presses very easy. More information on the operation and features of the decoder can be found in the MS Series Decoder Data Guide.

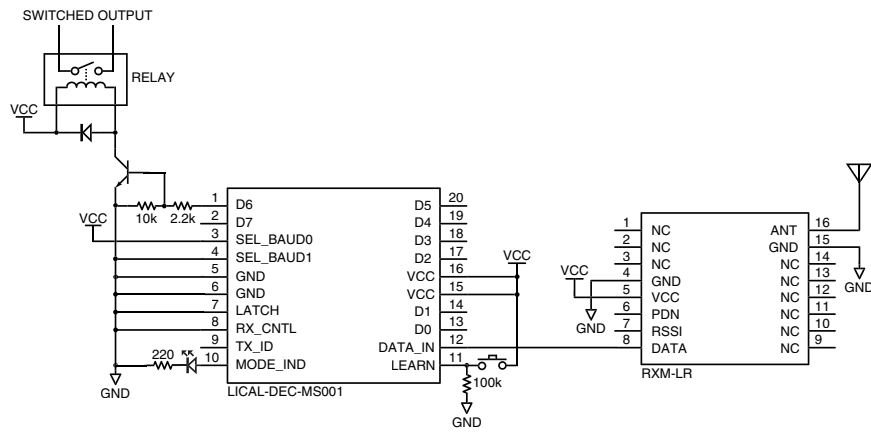

Figure 15: LR Series Receiver and MS Series Decoder

The receiver can also be connected to a GPIO of a microcontroller in applications that use a custom protocol. No buffering is generally required to drive a microcontroller input. Exceptions to this include systems where the microcontroller is operating at a different voltage from the receiver. In these cases the designer should take care to use voltage translator circuits as appropriate.

## Transferring Data

Once a reliable RF link has been established, the challenge becomes how to effectively transfer data across it. While a properly designed RF link provides reliable data transfer under most conditions, there are still distinct differences from a wired link that must be addressed. Since the LR Series modules do not incorporate internal encoding or decoding, a user has tremendous flexibility in how data is handled.

If the product transfers simple control or status signals such as button presses or switch closures and it does not have a microprocessor on board (or it is desired to avoid protocol development), consider using a remote control encoder and decoder or a transcoder IC. These chips are available from a wide range of manufacturers including Linx. They take care of all encoding and decoding functions, and generally provide a number of data pins to which switches can be directly connected. In addition, address bits are usually provided for security and to allow the addressing of multiple units independently. These ICs are an excellent way to bring basic remote control / status products to market quickly and inexpensively. Additionally, it is a simple task to interface with inexpensive microprocessors, IR, remote control or modem ICs.

It is always important to separate the types of transmissions that are technically possible from those that are legally allowable in the country of intended operation. Linx Application Notes AN-00125, AN-00128 and AN-00140 should be reviewed, along with Part 15, Section 231 of the Code of Federal Regulations for further details regarding acceptable transmission content in the US. All of these documents can be downloaded from the Linx website at [www.linxtechnologies.com](http://www.linxtechnologies.com).

Another area of consideration is that the data structure can affect the output power level. The FCC allows output power in the 260 to 470MHz band to be averaged over a 100ms time frame. Because OOK modulation activates the carrier for a '1' and deactivates the carrier for a '0', a data stream that sends more '0's has a lower average output power over 100ms. This allows the instantaneous output power to be increased, thus extending range.

## Antenna Considerations

The choice of antennas is a critical and often overlooked design consideration. The range, performance and legality of an RF link are critically dependent upon the antenna. While adequate antenna performance can often be obtained by trial and error methods, antenna design and matching is a complex



Figure 16: Linx Antennas

task. Professionally designed antennas such as those from Linx (Figure 16) help ensure maximum performance and FCC and other regulatory compliance.

Linx transmitter modules typically have an output power that is higher than the legal limits. This allows the designer to use an inefficient antenna such as a loop trace or helical to meet size, cost or cosmetic requirements and still achieve full legal output power for maximum range. If an efficient antenna is used, then some attenuation of the output power will likely be needed. This can easily be accomplished by using the LADJ line.

A receiver antenna should be optimized for the frequency or band in which the receiver operates and to minimize the reception of off-frequency signals. The efficiency of the receiver's antenna is critical to maximizing range performance. Unlike the transmitter antenna, where legal operation may mandate attenuation or a reduction in antenna efficiency, the receiver's antenna should be optimized as much as is practical.

It is usually best to utilize a basic quarter-wave whip until your prototype product is operating satisfactorily. Other antennas can then be evaluated based on the cost, size and cosmetic requirements of the product. Additional details are in Application Note AN-00500.

## Helpful Application Notes from Linx

It is not the intention of this manual to address in depth many of the issues that should be considered to ensure that the modules function correctly and deliver the maximum possible performance. We recommend reading the application notes listed in Figure 17 which address in depth key areas of RF design and application of Linx products. These applications notes are available online at [www.linxtechnologies.com](http://www.linxtechnologies.com) or by contacting Linx.

### Helpful Application Note Titles

Note Number	Note Title
AN-00100	RF 101: Information for the RF Challenged
AN-00125	Considerations for Operation Within the 260–470MHz Band
AN-00130	Modulation Techniques for Low-Cost RF Data Links
AN-00140	The FCC Road: Part 15 from Concept to Approval
AN-00150	Use and Design of T-Attenuation Pads
AN-00160	Considerations for Sending Data over a Wireless Link
AN-00232	General Considerations for Sending Data with the LC Series
AN-00500	Antennas: Design, Application, Performance
AN-00501	Understanding Antenna Specifications and Operation

Figure 17: Helpful Application Note Titles

## Protocol Guidelines

While many RF solutions impose data formatting and balancing requirements, Linx RF modules do not encode or packetize the signal content in any manner. The received signal will be affected by such factors as noise, edge jitter and interference, but it is not purposefully manipulated or altered by the modules. This gives the designer tremendous flexibility for protocol design and interface.

Despite this transparency and ease of use, it must be recognized that there are distinct differences between a wired and a wireless environment. Issues such as interference and contention must be understood and allowed for in the design process. To learn more about protocol considerations, read Linx Application Note AN-00160.

Interference or changing signal conditions can corrupt the data packet, so it is generally wise to structure the data being sent into small packets. This allows errors to be managed without affecting large amounts of data. A simple checksum or CRC could be used for basic error detection. Once an error is detected, the protocol designer may wish to simply discard the corrupt data or implement a more sophisticated scheme to correct it.

## Interference Considerations

The RF spectrum is crowded and the potential for conflict with unwanted sources of RF is very real. While all RF products are at risk from interference, its effects can be minimized by better understanding its characteristics.

Interference may come from internal or external sources. The first step is to eliminate interference from noise sources on the board. This means paying careful attention to layout, grounding, filtering and bypassing in order to eliminate all radiated and conducted interference paths. For many products, this is straightforward; however, products containing components such as switching power supplies, motors, crystals and other potential sources of noise must be approached with care. Comparing your own design with a Linx evaluation board can help to determine if and at what level design-specific interference is present.

External interference can manifest itself in a variety of ways. Low-level interference produces noise and hashing on the output and reduces the link's overall range.

High-level interference is caused by nearby products sharing the same frequency or from near-band high-power devices. It can even come from your own products if more than one transmitter is active in the same area. It is important to remember that only one transmitter at a time can occupy a frequency, regardless of the coding of the transmitted signal. This type of interference is less common than those mentioned previously, but in severe cases it can prevent all useful function of the affected device.

Although technically not interference, multipath is also a factor to be understood. Multipath is a term used to refer to the signal cancellation effects that occur when RF waves arrive at the receiver in different phase relationships. This effect is a particularly significant factor in interior environments where objects provide many different signal reflection paths. Multipath cancellation results in lowered signal levels at the receiver and shorter useful distances for the link.

## Pad Layout

The pad layout diagram in Figure 18 is designed to facilitate both hand and automated assembly.

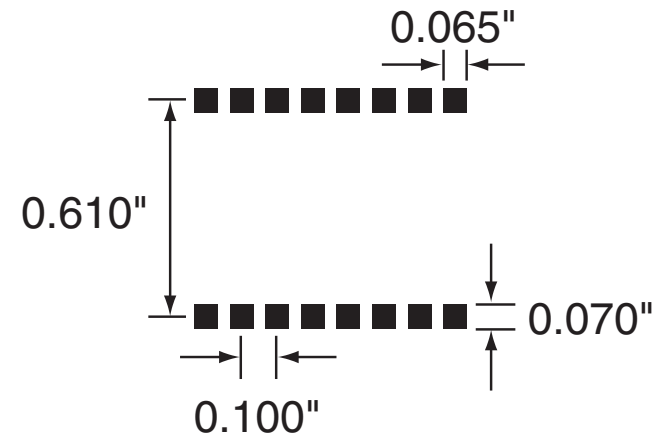

Figure 18: Recommended PCB Layout

## Board Layout Guidelines

The module's design makes integration straightforward; however, it is still critical to exercise care in PCB layout. Failure to observe good layout techniques can result in a significant degradation of the module's performance. A primary layout goal is to maintain a characteristic 50-ohm impedance throughout the path from the antenna to the module. Grounding, filtering, decoupling, routing and PCB stack-up are also important considerations for any RF design. The following section provides some basic design guidelines.

During prototyping, the module should be soldered to a properly laid-out circuit board. The use of prototyping or "perf" boards results in poor performance and is strongly discouraged. Likewise, the use of sockets can have a negative impact on the performance of the module and is discouraged.

The module should, as much as reasonably possible, be isolated from other components on your PCB, especially high-frequency circuitry such as crystal oscillators, switching power supplies, and high-speed bus lines.

When possible, separate RF and digital circuits into different PCB regions.

Make sure internal wiring is routed away from the module and antenna and is secured to prevent displacement.

Do not route PCB traces directly under the module. There should not be any copper or traces under the module on the same layer as the module, just bare PCB. The underside of the module has traces and vias that could short or couple to traces on the product's circuit board.

The Pad Layout section shows a typical PCB footprint for the module. A ground plane (as large and uninterrupted as possible) should be placed on a lower layer of your PCB board opposite the module. This plane is essential for creating a low impedance return for ground and consistent stripline performance.

Use care in routing the RF trace between the module and the antenna or connector. Keep the trace as short as possible. Do not pass it under the module or any other component. Do not route the antenna trace on multiple PCB layers as vias add inductance. Vias are acceptable for tying together ground layers and component grounds and should be used in multiples.

Each of the module's ground pins should have short traces tying immediately to the ground plane through a via.

Bypass caps should be low ESR ceramic types and located directly adjacent to the pin they are serving.

A 50-ohm coax should be used for connection to an external antenna. A 50-ohm transmission line, such as a microstrip, stripline or coplanar waveguide should be used for routing RF on the PCB. The Microstrip Details section provides additional information.

In some instances, a designer may wish to encapsulate or "pot" the product. There are a wide variety of potting compounds with varying dielectric properties. Since such compounds can considerably impact RF performance and the ability to rework or service the product, it is the responsibility of the designer to evaluate and qualify the impact and suitability of such materials.

## Microstrip Details

A transmission line is a medium whereby RF energy is transferred from one place to another with minimal loss. This is a critical factor, especially in high-frequency products like Linx RF modules, because the trace leading to the module's antenna can effectively contribute to the length of the antenna, changing its resonant bandwidth. In order to minimize loss and detuning, some form of transmission line between the antenna and the module should be used unless the antenna can be placed very close (<1/8in) to the module. One common form of transmission line is a coax cable and another is the microstrip. This term refers to a PCB trace running over a ground plane that is designed to serve as a transmission line between the module and the antenna. The width is based on the desired characteristic impedance of the line, the thickness of the PCB and the dielectric constant of the board material. For standard 0.062in thick FR-4 board material, the trace width would be 111 mils. The correct trace width can be calculated for other widths and materials using the information in Figure 19 and examples are provided in Figure 20. Software for calculating microstrip lines is also available on the Linx website.

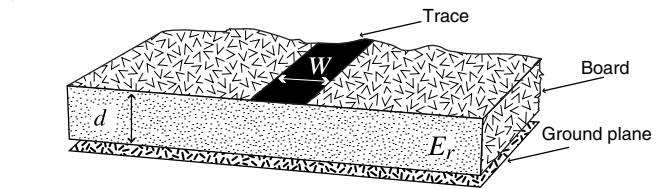

$$E_e = \frac{E_r + 1}{2} + \frac{E_r - 1}{2} \cdot \frac{1}{\sqrt{1 + 12d/W}}$$

$$Z_0 = \begin{cases} \frac{60}{\sqrt{E_e}} \cdot \ln\left(\frac{8d}{W} + \frac{W}{4d}\right) & \text{For } \frac{W}{d} \leq 1 \\ \frac{120\pi}{\sqrt{E_e} \cdot \left(\frac{W}{d} + 1.393 + 0.667 \cdot \ln\left(\frac{W}{d} + 1.444\right)\right)} & \text{For } \frac{W}{d} \geq 1 \end{cases}$$

$E_r$  = Dielectric constant of PCB material

Figure 19: Microstrip Formulas

Example Microstrip Calculations			
Dielectric Constant	Width / Height Ratio (W / d)	Effective Dielectric Constant	Characteristic Impedance (Ω)
4.80	1.8	3.59	50.0
4.00	2.0	3.07	51.0
2.55	3.0	2.12	48.8

Figure 20: Example Microstrip Calculations

## Production Guidelines

The module is housed in a hybrid SMD package that supports hand and automated assembly techniques. Since the modules contain discrete components internally, the assembly procedures are critical to ensuring the reliable function of the modules. The following procedures should be reviewed with and practiced by all assembly personnel.

## Hand Assembly

Pads located on the bottom of the module are the primary mounting surface (Figure 21). Since these pads are inaccessible during mounting, castellations that run up the side of the module have been provided to facilitate solder wicking to the module's underside. This allows for very

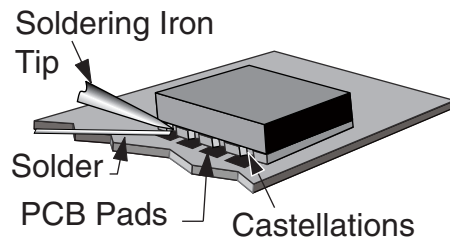

Figure 21: Soldering Technique

quick hand soldering for prototyping and small volume production. If the recommended pad guidelines have been followed, the pads will protrude slightly past the edge of the module. Use a fine soldering tip to heat the board pad and the castellation, then introduce solder to the pad at the module's edge. The solder will wick underneath the module, providing reliable attachment. Tack one module corner first and then work around the device, taking care not to exceed the times in Figure 22.

**Warning:** Pay attention to the absolute maximum solder times.

### Absolute Maximum Solder Times

Hand Solder Temperature: +427°C for 10 seconds for lead-free alloys

Reflow Oven: +255°C max (see Figure 23)

Figure 22: Absolute Maximum Solder Times

## Automated Assembly

For high-volume assembly, the modules are generally auto-placed. The modules have been designed to maintain compatibility with reflow processing techniques; however, due to their hybrid nature, certain aspects of the assembly process are far more critical than for other component types. Following are brief discussions of the three primary areas where caution must be observed.

## Reflow Temperature Profile

The single most critical stage in the automated assembly process is the reflow stage. The reflow profile in Figure 23 should not be exceeded because excessive temperatures or transport times during reflow will irreparably damage the modules. Assembly personnel need to pay careful attention to the oven's profile to ensure that it meets the requirements necessary to successfully reflow all components while still remaining within the limits mandated by the modules. The figure below shows the recommended reflow oven profile for the modules.

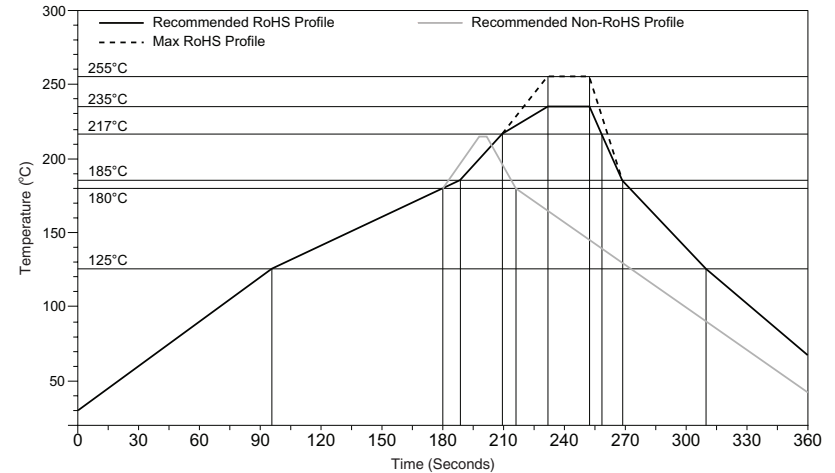

Figure 23: Maximum Reflow Temperature Profile

## Shock During Reflow Transport

Since some internal module components may reflow along with the components placed on the board being assembled, it is imperative that the modules not be subjected to shock or vibration during the time solder is liquid. Should a shock be applied, some internal components could be lifted from their pads, causing the module to not function properly.

## Washability

The modules are wash-resistant, but are not hermetically sealed. Linx recommends wash-free manufacturing; however, the modules can be subjected to a wash cycle provided that a drying time is allowed prior to applying electrical power to the modules. The drying time should be sufficient to allow any moisture that may have migrated into the module to evaporate, thus eliminating the potential for shorting damage during power-up or testing. If the wash contains contaminants, the performance may be adversely affected, even after drying.



## General Antenna Rules

The following general rules should help in maximizing antenna performance.

1. Proximity to objects such as a user's hand, body or metal objects will cause an antenna to detune. For this reason, the antenna shaft and tip should be positioned as far away from such objects as possible.
2. Optimum performance is obtained from a  $\frac{1}{4}$ - or  $\frac{1}{2}$ -wave straight whip mounted at a right angle to the ground plane (Figure 24). In many cases, this isn't desirable for practical or ergonomic reasons, thus, an alternative antenna style such as a helical, loop or patch may be utilized and the corresponding sacrifice in performance accepted.

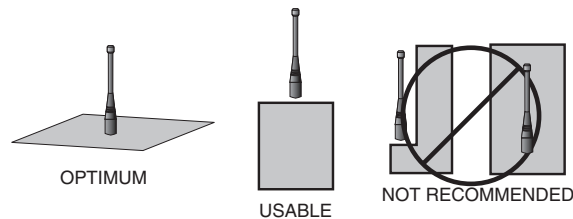

Figure 24: Ground Plane Orientation

3. If an internal antenna is to be used, keep it away from other metal components, particularly large items like transformers, batteries, PCB tracks and ground planes. In many cases, the space around the antenna is as important as the antenna itself. Objects in close proximity to the antenna can cause direct detuning, while those farther away will alter the antenna's symmetry.
4. In many antenna designs, particularly  $\frac{1}{4}$ -wave whips, the ground plane acts as a counterpoise, forming, in essence, a  $\frac{1}{2}$ -wave dipole (Figure 25). For this reason, adequate ground plane area is essential. The ground plane can be a metal case or ground-fill areas on a circuit board. Ideally, it should have a surface area less than or equal to the overall length of the  $\frac{1}{4}$ -wave radiating element. This is often not practical due to size and configuration constraints. In these instances, a designer must make the best use of the area available to create as much ground

### VERTICAL $\lambda/4$ GROUNDED ANTENNA (MARCONI)

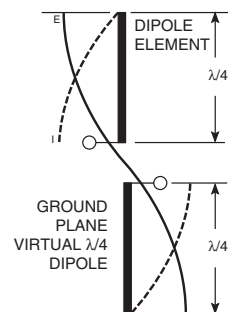

Figure 25: Dipole Antenna

plane as possible in proximity to the base of the antenna. In cases where the antenna is remotely located or the antenna is not in close proximity to a circuit board, ground plane or grounded metal case, a metal plate may be used to maximize the antenna's performance.

5. Remove the antenna as far as possible from potential interference sources. Any frequency of sufficient amplitude to enter the receiver's front end will reduce system range and can even prevent reception entirely. Switching power supplies, oscillators or even relays can also be significant sources of potential interference. The single best weapon against such problems is attention to placement and layout. Filter the module's power supply with a high-frequency bypass capacitor. Place adequate ground plane under potential sources of noise to shunt noise to ground and prevent it from coupling to the RF stage. Shield noisy board areas whenever practical.
6. In some applications, it is advantageous to place the module and antenna away from the main equipment (Figure 26). This can avoid interference problems and allows the antenna to be oriented for optimum performance. Always use  $50\Omega$  coax, like RG-174, for the remote feed.

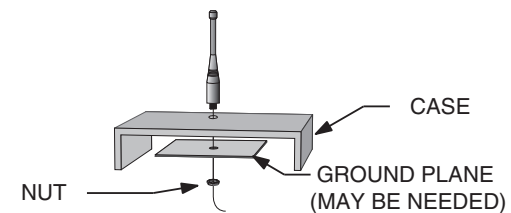

Figure 26: Remote Ground Plane

## Common Antenna Styles

There are hundreds of antenna styles and variations that can be employed with Linx RF modules. Following is a brief discussion of the styles most commonly utilized. Additional antenna information can be found in Linx Application Notes AN-00100, AN-00140, AN-00500 and AN-00501. Linx antennas and connectors offer outstanding performance at a low price.

### Whip Style

A whip style antenna (Figure 27) provides outstanding overall performance and stability. A low-cost whip can be easily fabricated from a wire or rod, but most designers opt for the consistent performance and cosmetic appeal of a professionally-made model. To meet this need, Linx offers a wide variety of straight and reduced height whip style antennas in permanent and connectorized mounting styles.



Figure 27: Whip Style Antennas

The wavelength of the operational frequency determines an antenna's overall length. Since a full wavelength is often quite long, a partial 1/2- or 1/4-wave antenna is normally employed. Its size and natural radiation resistance make it well matched to Linx modules. The proper length for a straight 1/4-wave can be easily determined using the formula in Figure 28. It is also possible to reduce the overall height of the antenna by using a helical winding. This reduces the antenna's bandwidth but is a great way to minimize the antenna's physical size for compact applications. This also means that the physical appearance is not always an indicator of the antenna's frequency.

$$L = \frac{234}{F_{\text{MHz}}}$$

Figure 28:  
L = length in feet of quarter-wave length  
F = operating frequency in megahertz

### Specialty Styles

Linx offers a wide variety of specialized antenna styles (Figure 29). Many of these styles utilize helical elements to reduce the overall antenna size while maintaining reasonable performance. A helical antenna's bandwidth is often quite narrow and the antenna can detune in proximity to other objects, so care must be exercised in layout and placement.



Figure 29: Specialty Style Antennas

### Loop Style

A loop or trace style antenna is normally printed directly on a product's PCB (Figure 30). This makes it the most cost-effective of antenna styles. The element can be made self-resonant or externally resonated with discrete components, but its actual layout is usually product specific. Despite the cost advantages, loop style antennas are generally inefficient and useful only for short range applications. They are also very sensitive to changes in layout and PCB dielectric, which can cause consistency issues during production. In addition, printed styles are difficult to engineer, requiring the use of expensive equipment including a network analyzer. An improperly designed loop will have a high VSWR at the desired frequency which can cause instability in the RF stage.



Figure 30: Loop or Trace Antenna

Linx offers low-cost planar (Figure 31) and chip antennas that mount directly to a product's PCB. These tiny antennas do not require testing and provide excellent performance despite their small size. They offer a preferable alternative to the often problematic "printed" antenna.



Figure 31: SP Series "Splatch" and uSP "MicroSplatch" Antennas



## Regulatory Considerations

**Note:** Linx RF modules are designed as component devices that require external components to function. The purchaser understands that additional approvals may be required prior to the sale or operation of the device, and agrees to utilize the component in keeping with all laws governing its use in the country of operation.

When working with RF, a clear distinction must be made between what is technically possible and what is legally acceptable in the country where operation is intended. Many manufacturers have avoided incorporating RF into their products as a result of uncertainty and even fear of the approval and certification process. Here at Linx, our desire is not only to expedite the design process, but also to assist you in achieving a clear idea of what is involved in obtaining the necessary approvals to legally market a completed product.

For information about regulatory approval, read AN-00142 on the Linx website or call Linx. Linx designs products with worldwide regulatory approval in mind.

In the United States, the approval process is actually quite straightforward. The regulations governing RF devices and the enforcement of them are the responsibility of the Federal Communications Commission (FCC). The regulations are contained in Title 47 of the United States Code of Federal Regulations (CFR). Title 47 is made up of numerous volumes; however, all regulations applicable to this module are contained in Volume 0-19. It is strongly recommended that a copy be obtained from the FCC's website, the Government Printing Office in Washington or from your local government bookstore. Excerpts of applicable sections are included with Linx evaluation kits or may be obtained from the Linx Technologies website, [www.linxtechnologies.com](http://www.linxtechnologies.com). In brief, these rules require that any device that intentionally radiates RF energy be approved, that is, tested for compliance and issued a unique identification number. This is a relatively painless process. Final compliance testing is performed by one of the many independent testing laboratories across the country. Many labs can also provide other certifications that the product may require at the same time, such as UL, CLASS A / B, etc. Once the completed product has passed, an ID number is issued that is to be clearly placed on each product manufactured.

Questions regarding interpretations of the Part 2 and Part 15 rules or the measurement procedures used to test intentional radiators such as Linx RF modules for compliance with the technical standards of Part 15 should be addressed to:

Federal Communications Commission  
Equipment Authorization Division  
Customer Service Branch, MS 1300F2  
7435 Oakland Mills Road  
Columbia, MD, US 21046  
Phone: + 1 301 725 585 | Fax: + 1 301 344 2050  
Email: [labinfo@fcc.gov](mailto:labinfo@fcc.gov)

ETSI Secretaria  
650, Route des Lucioles  
06921 Sophia-Antipolis Cedex  
FRANCE  
Phone: +33 (0)4 92 94 42 00  
Fax: +33 (0)4 93 65 47 16

International approvals are slightly more complex, although Linx modules are designed to allow all international standards to be met. If the end product is to be exported to other countries, contact Linx to determine the specific suitability of the module to the application.

All Linx modules are designed with the approval process in mind and thus much of the frustration that is typically experienced with a discrete design is eliminated. Approval is still dependent on many factors, such as the choice of antennas, correct use of the frequency selected and physical packaging. While some extra cost and design effort are required to address these issues, the additional usefulness and profitability added to a product by RF makes the effort more than worthwhile.

Notes



Linx Technologies  
159 Ort Lane  
Merlin, OR, US 97532

Phone: +1 541 471 6256  
Fax: +1 541 471 6251

[www.linxtechnologies.com](http://www.linxtechnologies.com)

#### Disclaimer

---

Linx Technologies is continually striving to improve the quality and function of its products. For this reason, we reserve the right to make changes to our products without notice. The information contained in this Data Guide is believed to be accurate as of the time of publication. Specifications are based on representative lot samples. Values may vary from lot-to-lot and are not guaranteed. "Typical" parameters can and do vary over lots and application. Linx Technologies makes no guarantee, warranty, or representation regarding the suitability of any product for use in any specific application. It is the customer's responsibility to verify the suitability of the part for the intended application. **NO LINX PRODUCT IS INTENDED FOR USE IN ANY APPLICATION WHERE THE SAFETY OF LIFE OR PROPERTY IS AT RISK.**

Linx Technologies **DISCLAIMS ALL WARRANTIES OF MERCHANTABILITY AND FITNESS FOR A PARTICULAR PURPOSE. IN NO EVENT SHALL LINX TECHNOLOGIES BE LIABLE FOR ANY OF CUSTOMER'S INCIDENTAL OR CONSEQUENTIAL DAMAGES ARISING IN ANY WAY FROM ANY DEFECTIVE OR NON-CONFORMING PRODUCTS OR FOR ANY OTHER BREACH OF CONTRACT BY LINX TECHNOLOGIES.** The limitations on Linx Technologies' liability are applicable to any and all claims or theories of recovery asserted by Customer, including, without limitation, breach of contract, breach of warranty, strict liability, or negligence. Customer assumes all liability (including, without limitation, liability for injury to person or property, economic loss, or business interruption) for all claims, including claims from third parties, arising from the use of the Products. The Customer will indemnify, defend, protect, and hold harmless Linx Technologies and its officers, employees, subsidiaries, affiliates, distributors, and representatives from and against all claims, damages, actions, suits, proceedings, demands, assessments, adjustments, costs, and expenses incurred by Linx Technologies as a result of or arising from any Products sold by Linx Technologies to Customer. Under no conditions will Linx Technologies be responsible for losses arising from the use or failure of the device in any application, other than the repair, replacement, or refund limited to the original product purchase price. Devices described in this publication may contain proprietary, patented, or copyrighted techniques, components, or materials. Under no circumstances shall any user be conveyed any license or right to the use or ownership of such items.

---

©2015 Linx Technologies. All rights reserved.

The stylized Linx logo, Wireless Made Simple, WISE, CipherLinx and the stylized CL logo are trademarks of Linx Technologies.