



**TAOS Inc.**

**is now**

**ams AG**

The technical content of this TAOS datasheet is still valid.

**Contact information:**

**Headquarters:**

ams AG

Tobelbaderstrasse 30

8141 Unterpremstaetten, Austria

Tel: +43 (0) 3136 500 0

e-Mail: [ams\\_sales@ams.com](mailto:ams_sales@ams.com)

Please visit our website at [www.ams.com](http://www.ams.com)

## Features

- **Ambient Light Sensing (ALS)**
  - Approximates Human Eye Response
  - Programmable Analog Gain
  - Programmable Integration Time
  - Programmable Interrupt Function with Upper and Lower Threshold
  - Resolution Up to 16 Bits
  - Very High Sensitivity — Operates Well Behind Darkened Glass
  - Up to 1,000,000:1 Dynamic Range
- **Programmable Wait Timer**
  - Programmable from 2.72 ms to > 8 Seconds
  - Wait State — 65  $\mu$ A Typical Current
- **I<sup>2</sup>C Interface Compatible**
  - Up to 400 kHz (I<sup>2</sup>C Fast Mode)
  - Dedicated Interrupt Pin
- **Small 2 mm × 2 mm ODFN Package**
- **Sleep Mode — 2.5  $\mu$ A Typical Current**

PACKAGE FN  
DUAL FLAT NO-LEAD  
(TOP VIEW)

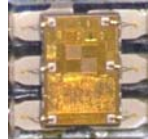
V <sub>DD</sub> 1		6 SDA
SCL 2		5 INT
GND 3		4 NC

## Applications

- Display Management
- Backlight Control
- Portable Device Power Optimization
- Cell Phones, PDA, GPS
- Notebooks and Monitors
- LCD TVs

## Description

The TSL2571 family of devices provides ambient light sensing (ALS) that approximates human eye response to light intensity under a variety of lighting conditions and through a variety of attenuation materials. While useful for general purpose light sensing, the device is particularly useful for display management with the purpose of extending battery life and providing optimum viewing in diverse lighting conditions. Display panel and keyboard backlighting can account for up to 30 to 40 percent of total platform power. The ALS features are ideal for use in notebook PCs, LCD monitors, flat-panel televisions, and cell phones.

## Functional Block Diagram

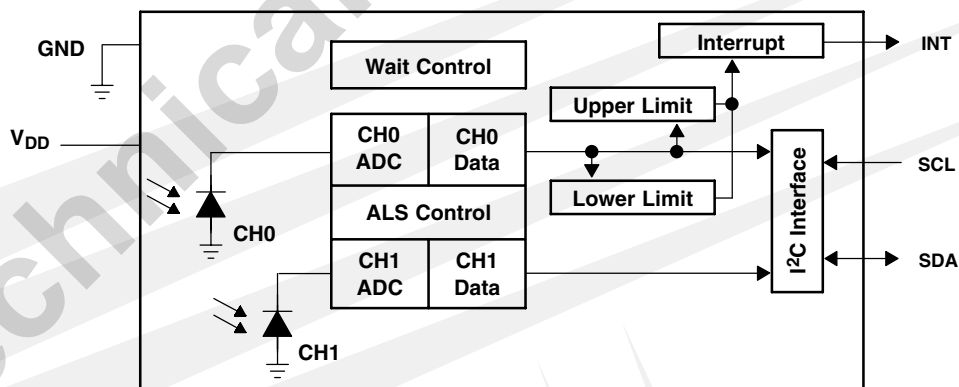

# TSL2571 LIGHT-TO-DIGITAL CONVERTER

TAOS117A – FEBRUARY 2011

---

## Detailed Description

The TSL2571 light-to-digital device includes on-chip photodiodes, integrating amplifiers, ADCs, accumulators, clocks, buffers, comparators, a state machine, and an I<sup>2</sup>C interface. The device combines one photodiode (CH0), which is responsive to both visible and infrared light, and one photodiode (CH1), which is responsive primarily to infrared light. Two integrating ADCs simultaneously convert the amplified photodiode currents into a digital value providing up to 16 bits of resolution. Upon completion of the conversion cycle, the conversion result is transferred to the data registers. This digital output can be read by a microprocessor through which the illuminance (ambient light level) in lux is derived using an empirical formula to approximate the human eye response.

Communication to the device is accomplished through a fast (up to 400 kHz), two-wire I<sup>2</sup>C serial bus for easy connection to a microcontroller or embedded controller. The digital output of the device is inherently more immune to noise when compared to an analog interface.

The device provides a separate pin for level-style interrupts. When interrupts are enabled and a pre-set value is exceeded, the interrupt pin is asserted and remains asserted until cleared by the controlling firmware. The interrupt feature simplifies and improves system efficiency by eliminating the need to poll a sensor for a light intensity value. An interrupt is generated when the value of an ALS conversion exceeds either an upper or lower threshold. In addition, a programmable interrupt persistence feature allows the user to determine how many consecutive exceeded thresholds are necessary to trigger an interrupt. Interrupt thresholds and persistence settings are configured independently.

## Terminal Functions

TERMINAL NAME	NO.	TYPE	DESCRIPTION
GND	3		Power supply ground. All voltages are referenced to GND.
INT	5	O	Interrupt — open drain (active low).
NC	4		Do not connect.
SCL	2	I	I <sup>2</sup> C serial clock input terminal — clock signal for I <sup>2</sup> C serial data.
SDA	6	I/O	I <sup>2</sup> C serial data I/O terminal — serial data I/O for I <sup>2</sup> C .
V <sub>DD</sub>	1		Supply voltage.

## Available Options

DEVICE	ADDRESS	PACKAGE – LEADS	INTERFACE DESCRIPTION	ORDERING NUMBER
TSL25711	0x39	FN–6	I <sup>2</sup> C V <sub>bus</sub> = V <sub>DD</sub> Interface	TSL25711FN
TSL25713	0x39	FN–6	I <sup>2</sup> C V <sub>bus</sub> = 1.8 V Interface	TSL25713FN
TSL25715†	0x29	FN–6	I <sup>2</sup> C V <sub>bus</sub> = V <sub>DD</sub> Interface	TSL25715FN
TSL25717†	0x29	FN–6	I <sup>2</sup> C V <sub>bus</sub> = 1.8 V Interface	TSL25717FN

† Contact TAOS for availability.

## Absolute Maximum Ratings over operating free-air temperature range (unless otherwise noted)†

Supply voltage, V <sub>DD</sub> (see Note 1)	3.8 V
Digital output voltage range, V <sub>O</sub>	–0.5 V to 3.8 V
Digital output current, I <sub>O</sub>	–1 mA to 20 mA
Storage temperature range, T <sub>stg</sub>	–40°C to 85°C
ESD tolerance, human body model	2000 V

† Stresses beyond those listed under “absolute maximum ratings” may cause permanent damage to the device. These are stress ratings only, and functional operation of the device at these or any other conditions beyond those indicated under “recommended operating conditions” is not implied. Exposure to absolute-maximum-rated conditions for extended periods may affect device reliability.

NOTE 1: All voltages are with respect to GND.

## Recommended Operating Conditions

	MIN	NOM	MAX	UNIT
Supply voltage, V <sub>DD</sub>	2.6	3	3.6	V
Operating free-air temperature, T <sub>A</sub>	–30		70	°C



# TSL2571 LIGHT-TO-DIGITAL CONVERTER

TAOS117A – FEBRUARY 2011

## Operating Characteristics, $V_{DD} = 3\text{ V}$ , $T_A = 25^\circ\text{C}$ (unless otherwise noted)

PARAMETER		TEST CONDITIONS	MIN	TYP	MAX	UNIT
$I_{DD}$	Supply current	Active		175	250	$\mu\text{A}$
		Wait mode		65		
		Sleep mode — no $I^2\text{C}$ activity		2.5	4	
$V_{OL}$	INT, SDA output low voltage	3 mA sink current	0		0.4	V
		6 mA sink current	0		0.6	
$I_{LEAK}$	Leakage current, SDA, SCL, INT pins		-5		5	$\mu\text{A}$
$V_{IH}$	SCL, SDA input high voltage	TSL25711, TSL25715	0.7 $V_{DD}$			V
		TSL25713, TSL25717	1.25			
$V_{IL}$	SCL, SDA input low voltage	TSL25711, TSL25715	0.3 $V_{DD}$			V
		TSL25713, TSL25717	0.54			

## ALS Characteristics, $V_{DD} = 3\text{ V}$ , $T_A = 25^\circ\text{C}$ , Gain = 16, AEN = 1 (unless otherwise noted) (Notes 1, 2, 3)

PARAMETER		TEST CONDITIONS	CHANNEL	MIN	TYP	MAX	UNIT
Dark ADC count value	$E_e = 0$ , AGAIN = 120X, ATIME = 0xDB (100 ms)		CH0	0	1	5	counts
			CH1	0	1	5	
ADC integration time step size	ATIME = 0xFF			2.58	2.72	2.9	ms
ADC Number of integration steps				1		256	steps
ADC counts per step	ATIME = 0xFF			0		1024	counts
ADC count value	ATIME = 0xC0			0		65535	counts
ADC count value	$\lambda_p = 625\text{ nm}$ , $E_e = 171.6\ \mu\text{W}/\text{cm}^2$ , ATIME = 0xF6 (27 ms) See note 2.		CH0	4000	5000	6000	counts
			CH1		790		
			CH0	4000	5000	6000	
			CH1		2800		
ADC count value ratio: CH1/CH0	$\lambda_p = 625\text{ nm}$ , ATIME = 0xF6 (27 ms) See note 2. $\lambda_p = 850\text{ nm}$ , ATIME = 0xF6 (27 ms) See note 3.			10.8	15.8	20.8	%
				41	56	68	
$R_e$	Irradiance responsivity	$\lambda_p = 625\text{ nm}$ , ATIME = 0xF6 (27 ms) See note 2.	CH0		29.1		counts/ ( $\mu\text{W}/\text{cm}^2$ )
			CH1		4.6		
		$\lambda_p = 850\text{ nm}$ , ATIME = 0xF6 (27 ms) See note 3.	CH0		22.8		
			CH1		12.7		
Gain scaling, relative to 1X gain setting			8X	-10		10	%
			16X	-10		10	
			120X	-10		10	

- NOTES: 1. Optical measurements are made using small-angle incident radiation from light-emitting diode optical sources. Visible 625 nm LEDs and infrared 850 nm LEDs are used for final product testing for compatibility with high-volume production.
2. The 625 nm irradiance  $E_e$  is supplied by an AlInGaP light-emitting diode with the following typical characteristics: peak wavelength  $\lambda_p = 625\text{ nm}$  and spectral halfwidth  $\Delta\lambda_{1/2} = 20\text{ nm}$ .
3. The 850 nm irradiance  $E_e$  is supplied by a GaAs light-emitting diode with the following typical characteristics: peak wavelength  $\lambda_p = 850\text{ nm}$  and spectral halfwidth  $\Delta\lambda_{1/2} = 42\text{ nm}$ .

Wait Characteristics,  $V_{DD} = 3\text{ V}$ ,  $T_A = 25^\circ\text{C}$ , WEN = 1 (unless otherwise noted)

PARAMETER	TEST CONDITIONS	CHANNEL	MIN	TYP	MAX	UNIT
Wait step size	WTIME = 0xFF		2.58	2.72	2.9	ms
Wait number of integration steps			1		256	steps

AC Electrical Characteristics,  $V_{DD} = 3\text{ V}$ ,  $T_A = 25^\circ\text{C}$  (unless otherwise noted)

PARAMETER†	TEST CONDITIONS	MIN	TYP	MAX	UNIT
$f_{(SCL)}$ Clock frequency (I <sup>2</sup> C only)		0		400	kHz
$t_{(BUF)}$ Bus free time between start and stop condition		1.3			$\mu\text{s}$
$t_{(HDSTA)}$ Hold time after (repeated) start condition. After this period, the first clock is generated.		0.6			$\mu\text{s}$
$t_{(SUSTA)}$ Repeated start condition setup time		0.6			$\mu\text{s}$
$t_{(SUSTO)}$ Stop condition setup time		0.6			$\mu\text{s}$
$t_{(HDDAT)}$ Data hold time		0			$\mu\text{s}$
$t_{(SUDAT)}$ Data setup time		100			ns
$t_{(LOW)}$ SCL clock low period		1.3			$\mu\text{s}$
$t_{(HIGH)}$ SCL clock high period		0.6			$\mu\text{s}$
$t_F$ Clock/data fall time				300	ns
$t_R$ Clock/data rise time				300	ns
$C_i$ Input pin capacitance				10	pF

† Specified by design and characterization; not production tested.

PARAMETER MEASUREMENT INFORMATION

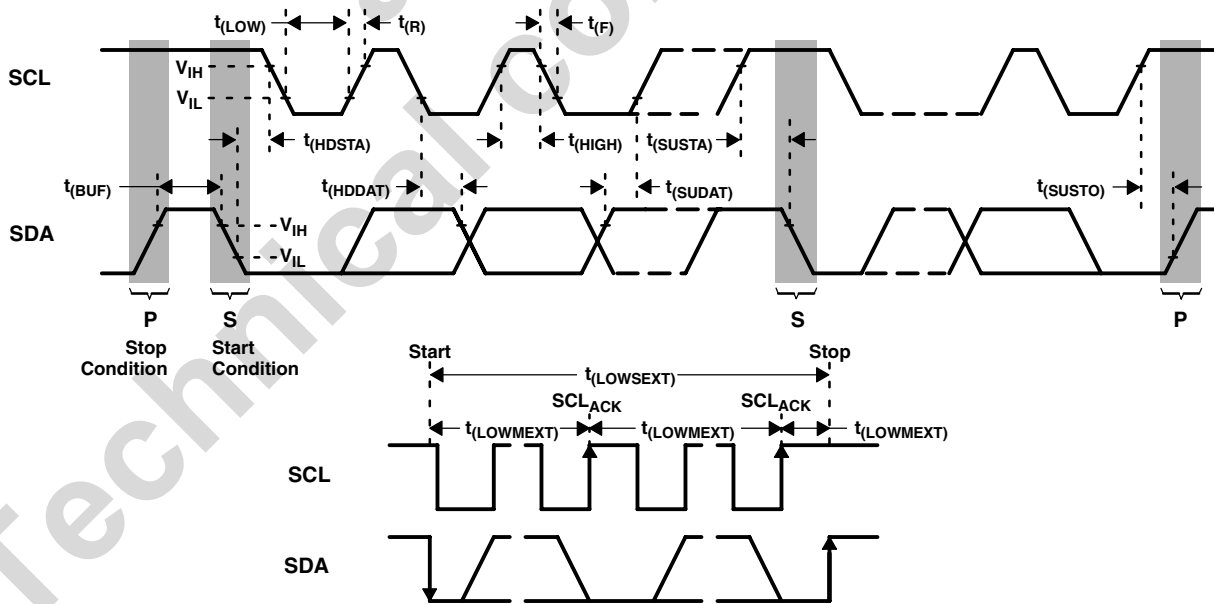
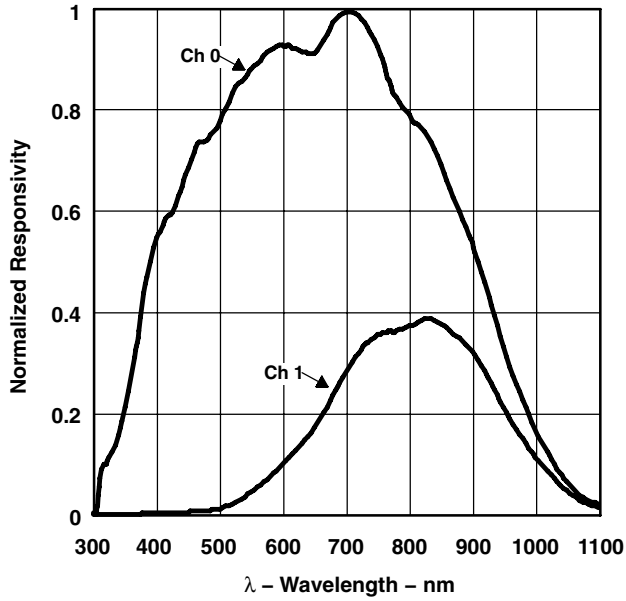

Figure 1. Timing Diagrams

**TYPICAL CHARACTERISTICS**

**SPECTRAL RESPONSIVITY**



**Figure 2**

**NORMALIZED  $I_{DD}$   
vs.  
 $V_{DD}$  and TEMPERATURE**

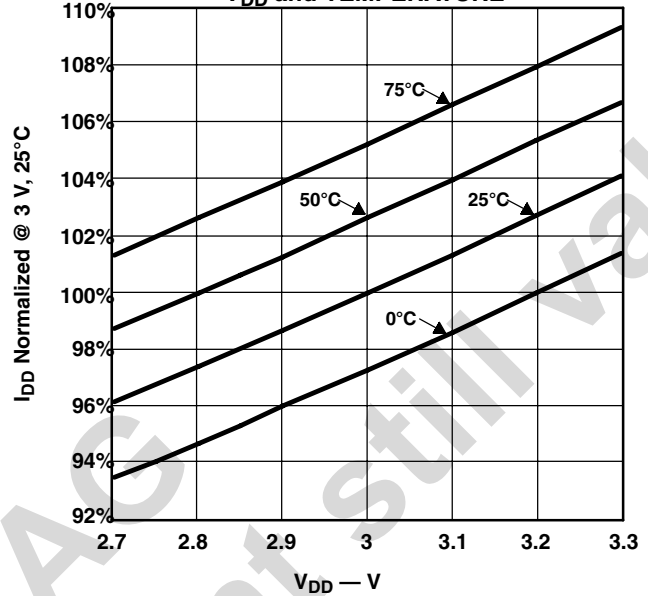

**Figure 3**

**NORMALIZED RESPONSIVITY  
vs.  
ANGULAR DISPLACEMENT**

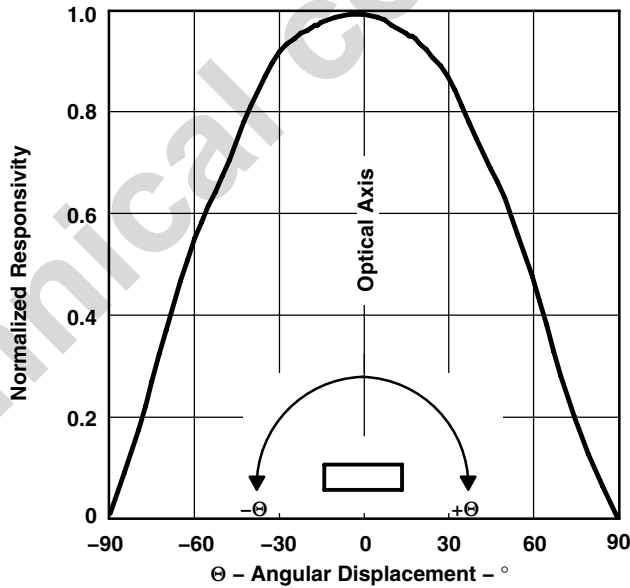

**Figure 4**

PRINCIPLES OF OPERATION

System State Machine

The device provides control of ALS and power management functionality through an internal state machine (Figure 5). After a power-on-reset, the device is in the sleep mode. As soon as the PON bit is set, the device will move to the start state. It will then continue through the Wait and ALS states. If these states are enabled, the device will execute each function. If the PON bit is set to 0, the state machine will continue until all conversions are completed and then go into a low power sleep mode.

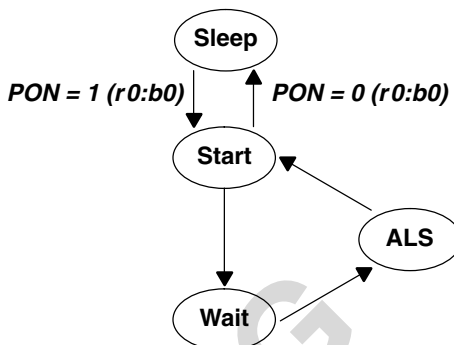

Figure 5. Simplified State Diagram

**NOTE:** In this document, the nomenclature uses the bit field name in italic followed by the register number and bit number to allow the user to easily identify the register and bit that controls the function. For example, the power on (PON) is in register 0, bit 0. This is represented as *PON (r0:b0)*.

Photodiodes

Conventional silicon detectors respond strongly to infrared light, which the human eye does not see. This can lead to significant error when the infrared content of the ambient light is high (such as with incandescent lighting) due to the difference between the silicon detector response and the brightness perceived by the human eye.

This problem is overcome through the use of two photodiodes. The channel 0 photodiode, referred to as the CH0 channel, is sensitive to both visible and infrared light, while the channel 1 photodiode, referred to as CH1, is sensitive primarily to infrared light. Two integrating ADCs convert the photodiode currents to digital outputs. The ADC digital outputs from the two channels are used in a formula to obtain a value that approximates the human eye response in units of lux.



# TSL2571 LIGHT-TO-DIGITAL CONVERTER

TAOS117A – FEBRUARY 2011

## ALS Operation

The ALS engine contains ALS gain control (AGAIN) and two integrating analog-to-digital converters (ADC) for the Channel 0 and Channel 1 photodiodes. The ALS integration time (ATIME) impacts both the resolution and the sensitivity of the ALS reading. Integration of both channels occurs simultaneously and upon completion of the conversion cycle, the results are transferred to the data registers (C0DATA and C1DATA). This data is also referred to as channel *count*. The transfers are double-buffered to ensure data integrity.

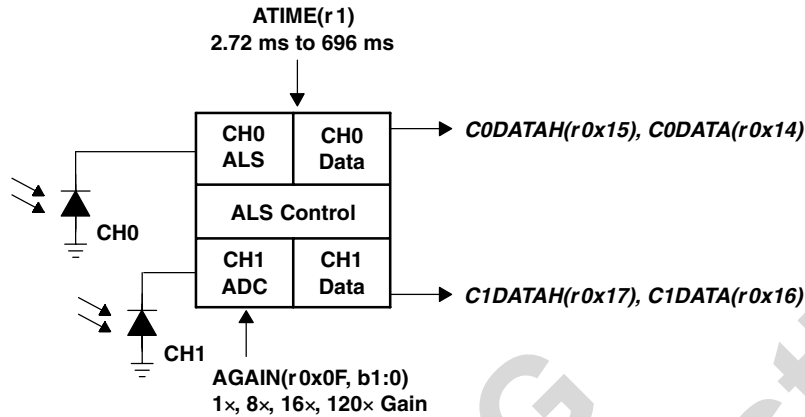

Figure 6. ALS Operation

The registers for programming the integration and wait times are a 2's complement values. The actual time can be calculated as follows:

$$ATIME = 256 - \text{Integration Time} / 2.72 \text{ ms}$$

Inversely, the time can be calculated from the register value as follows:

$$\text{Integration Time} = 2.72 \text{ ms} \times (256 - ATIME)$$

In order to reject 50/60-Hz ripple strongly present in fluorescent lighting, the integration time needs to be programmed in multiples of 10 / 8.3 ms or the half cycle time. Both frequencies can be rejected with a programmed value of 50 ms (ATIME = 0xED) or multiples of 50 ms (i.e. 100, 150, 200, 400, 600).

The registers for programming the AGAIN hold a two-bit value representing a gain of 1x, 8x, 16x, or 120x. The gain, in terms of amount of gain, will be represented by the value AGAINx, i.e. AGAINx = 1, 8, 16, or 120.

## Lux Equation

The lux calculation is a function of CH0 channel count (C0DATA), CH1 channel count (C1DATA), ALS gain (AGAINx), and ALS integration time in milliseconds (ATIME\_ms). If an aperture, glass/plastic, or a light pipe attenuates the light equally across the spectrum (300 nm to 1100 nm), then a scaling factor referred to as glass attenuation (GA) can be used to compensate for attenuation. For a device in open air with no aperture or glass/plastic above the device, GA = 1. If it is not spectrally flat, then a custom lux equation with new coefficients should be generated. (See TAOS application note).

Counts per Lux (CPL) needs to be calculated only when ATIME or AGAIN is changed, otherwise it remains a constant. The first segment of the equation (Lux1) covers fluorescent and incandescent light. The second segment (Lux2) covers dimmed incandescent light. The final lux is the maximum of Lux1, Lux2, or 0.

$$\begin{aligned} CPL &= (ATIME\_ms \times AGAINx) / (GA \times 53) \\ Lux1 &= (C0DATA - 2 \times C1DATA) / CPL \\ Lux2 &= (0.6 \times C0DATA - C1DATA) / CPL \\ Lux &= \text{MAX}(Lux1, Lux2, 0) \end{aligned}$$

## Interrupts

The interrupt feature simplifies and improves system efficiency by eliminating the need to poll the sensor for light intensity values outside of a user-defined range. While the interrupt function is always enabled and its status is available in the status register (0x13), the output of the interrupt state can be enabled using the ALS interrupt enable (AIEN) field in the enable register (0x00).

Two 16-bit interrupt threshold registers allow the user to set limits below and above a desired light level range. An interrupt can be generated when the ALS CH0 data (C0DATA) falls outside of the desired light level range, as determined by the values in the ALS interrupt low threshold registers (AILTx) and ALS interrupt high threshold registers (AIHTx). It is important to note that the low threshold value must be less than the high threshold value for proper operation.

To further control when an interrupt occurs, the device provides a persistence filter. The persistence filter allows the user to specify the number of consecutive out-of-range ALS occurrences before an interrupt is generated. The persistence register (0x0C) allows the user to set the ALS persistence (APERS) value. See the persistence register for details on the persistence filter values. Once the persistence filter generates an interrupt, it will continue until a special function interrupt clear command is received (see command register).

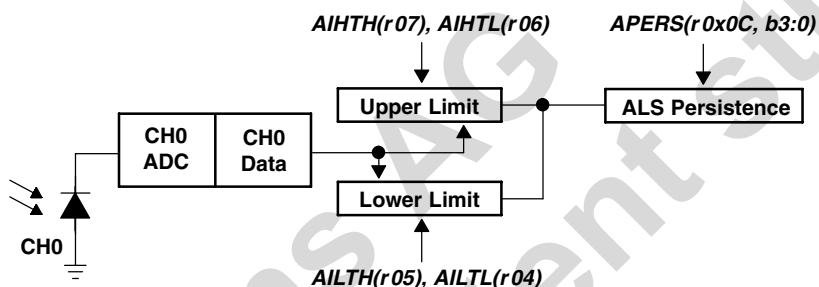

Figure 7. Programmable Interrupt

**State Diagram**

Figure 8 shows a more detailed flow for the state machine. The device starts in the sleep mode. The PON bit is written to enable the device. A 2.72-ms delay will occur before entering the start state.

If the WEN bit is set, the state machine will then cycle through the wait state. If the WLONG bit is set, the wait cycles are extended by 12× over normal operation. When the wait counter terminates, the state machine will step to the ALS state.

The AEN should always be set. In this case, a minimum of 1 integration time step should be programmed. The ALS state machine will continue until it reaches the terminal count at which point the data will be latched in the ALS register and the interrupt set, if enabled.

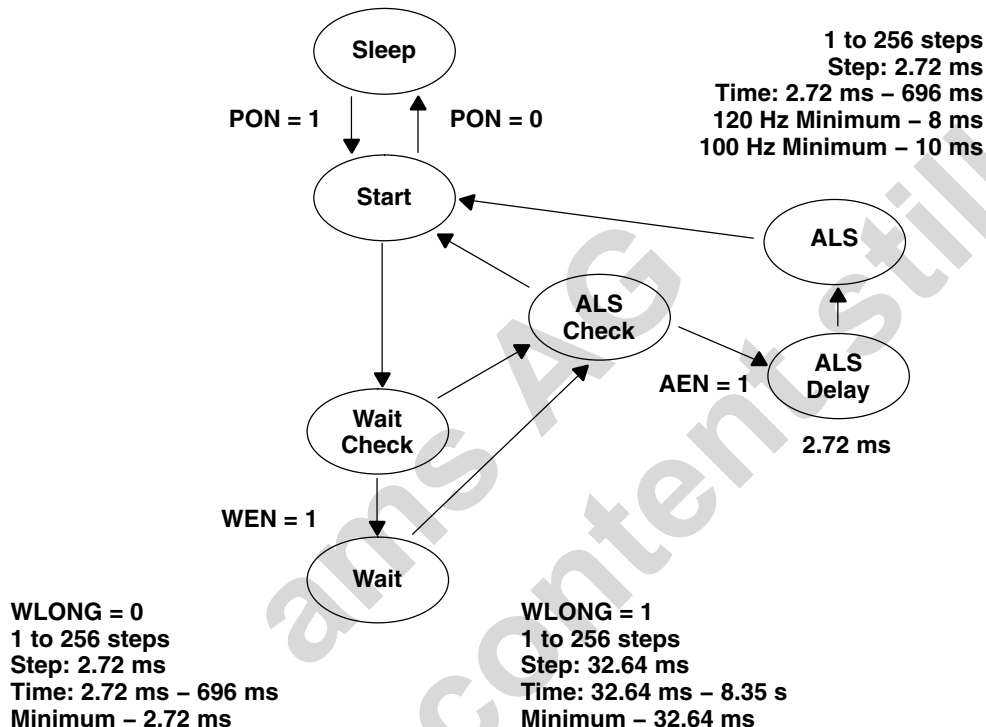

**Figure 8. Expanded State Diagram**

## I<sup>2</sup>C Protocol

Interface and control are accomplished through an I<sup>2</sup>C serial compatible interface (standard or fast mode) to a set of registers that provide access to device control functions and output data. The devices support the 7-bit I<sup>2</sup>C addressing protocol.

The I<sup>2</sup>C standard provides for three types of bus transaction: read, write, and a combined protocol (Figure 17). During a write operation, the first byte written is a command byte followed by data. In a combined protocol, the first byte written is the command byte followed by reading a series of bytes. If a read command is issued, the register address from the previous command will be used for data access. Likewise, if the MSB of the command is not set, the device will write a series of bytes at the address stored in the last valid command with a register address. The command byte contains either control information or a 5-bit register address. The control commands can also be used to clear interrupts.

The I<sup>2</sup>C bus protocol was developed by Philips (now NXP). For a complete description of the I<sup>2</sup>C protocol, please review the NXP I<sup>2</sup>C design specification at <http://www.i2c-bus.org/references/>.

- A Acknowledge (0)
- N Not Acknowledged (1)
- P Stop Condition
- R Read (1)
- S Start Condition
- S Repeated Start Condition
- W Write (0)
- ... Continuation of protocol
- ☐ Master-to-Slave
- ▣ Slave-to-Master

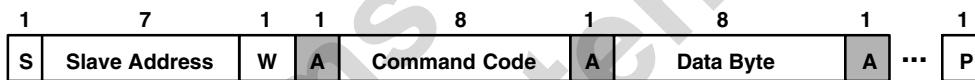

I<sup>2</sup>C Write Protocol



I<sup>2</sup>C Read Protocol

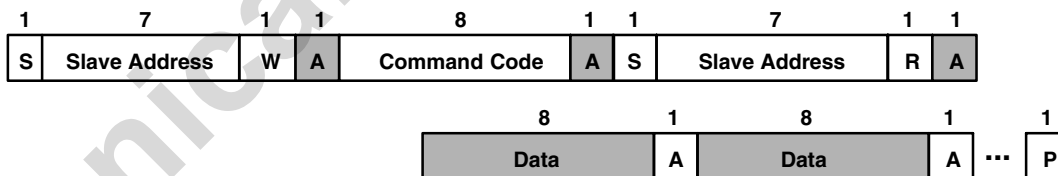

I<sup>2</sup>C Read Protocol — Combined Format

Figure 9. I<sup>2</sup>C Protocols

# TSL2571 LIGHT-TO-DIGITAL CONVERTER

TAOS117A – FEBRUARY 2011

## Register Set

The device is controlled and monitored by data registers and a command register accessed through the serial interface. These registers provide for a variety of control functions and can be read to determine results of the ADC conversions. The register set is summarized in Table 1.

**Table 1. Register Address**

ADDRESS	REGISTER NAME	R/W	REGISTER FUNCTION	RESET VALUE
--	COMMAND	W	Specifies register address	0x00
0x00	ENABLE	R/W	Enables states and interrupts	0x00
0x01	ATIME	R/W	ALS ADC time	0xFF
0x03	WTIME	R/W	Wait time	0xFF
0x04	AIDL	R/W	ALS interrupt low threshold low byte	0x00
0x05	AIDLH	R/W	ALS interrupt low threshold high byte	0x00
0x06	AIDLH	R/W	ALS interrupt high threshold low byte	0x00
0x07	AIDLH	R/W	ALS interrupt high threshold high byte	0x00
0x0C	PERS	R/W	Interrupt persistence filters	0x00
0x0D	CONFIG	R/W	Configuration	0x00
0x0F	CONTROL	R/W	Control register	0x00
0x12	ID	R	Device ID	ID
0x13	STATUS	R	Device status	0x00
0x14	C0DATA	R	CH0 ADC low data register	0x00
0x15	C0DATAH	R	CH0 ADC high data register	0x00
0x16	C1DATA	R	CH1 ADC low data register	0x00
0x17	C1DATAH	R	CH1 ADC high data register	0x00

The mechanics of accessing a specific register depends on the specific protocol used. See the section on I<sup>2</sup>C protocols on the previous pages. In general, the COMMAND register is written first to specify the specific control/status register for following read/write operations.

## Command Register

The command registers specifies the address of the target register for future write and read operations.

**Table 2. Command Register**

	7	6	5	4	3	2	1	0	
<b>COMMAND</b>	<b>COMMAND</b>	<b>TYPE</b>			<b>ADD</b>				--

FIELD	BITS	DESCRIPTION	
COMMAND	7	Select Command Register. Must write as 1 when addressing COMMAND register.	
TYPE	6:5	Selects type of transaction to follow in subsequent data transfers:	
		<b>FIELD VALUE</b>	<b>DESCRIPTION</b>
		00	Repeated byte protocol transaction
		01	Auto-increment protocol transaction
		10	Reserved — Do not use
		11	Special function — See description below
		Transaction type 00 will repeatedly read the same register with each data access. Transaction type 01 will provide an auto-increment function to read successive register bytes.	
ADD	4:0	Address register/special function field. Depending on the transaction type, see above, this field either specifies a special function command or selects the specific control-status-register for following write and read transactions. The field values listed below apply only to special function commands:	
		<b>FIELD VALUE</b>	<b>DESCRIPTION</b>
		00000	Normal — no action
		00110	ALS interrupt clear
		other	Reserved — do not write
		ALS interrupt clear — clears any pending ALS interrupt. This special function is self clearing.	

# TSL2571 LIGHT-TO-DIGITAL CONVERTER

TAOS117A – FEBRUARY 2011

## Enable Register (0x00)

The ENABLE register is used to power the device on/off, enable functions, and interrupts.

**Table 3. Enable Register**

	7	6	5	4	3	2	1	0	
ENABLE	Reserved		AIEN	WEN	Reserved	AEN	PON	Address 0x00	

FIELD	BITS	DESCRIPTION
Reserved	7:5	Reserved. Write as 0.
AIEN	4	ALS interrupt mask. When asserted, permits ALS interrupts to be generated.
WEN	3	Wait enable. This bit activates the wait feature. Writing a 1 activates the wait timer. Writing a 0 disables the wait timer.
Reserved	2	Reserved. Write as 0.
AEN	1	ALS Enable. Writing a 1 activates the ALS. Writing a 0 disables the ALS.
PON <sup>1</sup>	0	Power ON. This bit activates the internal oscillator to permit the timers and ADC channels to operate. Writing a 1 activates the oscillator. Writing a 0 disables the oscillator.

NOTE 1: A minimum interval of 2.72 ms must pass after PON is asserted before ALS can be initiated. This required time is enforced by the hardware in cases where the firmware does not provide it.

## ALS Timing Register (0x01)

The ALS timing register controls the internal integration time of the ALS ADCs in 2.72-ms increments.

**Table 4. ALS Timing Register**

FIELD	BITS	DESCRIPTION			
		VALUE	INTEG_CYCLES	TIME	MAX COUNT
ATIME	7:0	0xFF	1	2.72 ms	1024
		0xF6	10	27.2 ms	10240
		0xDB	37	101 ms	37888
		0xC0	64	174 ms	65535
		0x00	256	696 ms	65535

### Wait Time Register (0x03)

Wait time is set 2.72 ms increments unless the WLONG bit is asserted in which case the wait times are 12X longer. WTIME is programmed as a 2's complement number.

**Table 5. Wait Time Register**

FIELD	BITS	DESCRIPTION			
		REGISTER VALUE	WAIT TIME	TIME (WLONG = 0)	TIME (WLONG = 1)
WTIME	7:0	0xFF	1	2.72 ms	0.032 sec
		0xB6	74	201 ms	2.4 sec
		0x00	256	696 ms	8.3 sec

NOTE: The Wait Time Register should be configured before AEN is asserted.

### ALS Interrupt Threshold Registers (0x04 – 0x07)

The ALS interrupt threshold registers provides the values to be used as the high and low trigger points for the comparison function for interrupt generation. If C0DATA crosses below the low threshold specified, or above the higher threshold, an interrupt is asserted on the interrupt pin.

**Table 6. ALS Interrupt Threshold Registers**

REGISTER	ADDRESS	BITS	DESCRIPTION
AILTL	0x04	7:0	ALS low threshold lower byte
AILTH	0x05	7:0	ALS low threshold upper byte
AIHTL	0x06	7:0	ALS high threshold lower byte
AIHTH	0x07	7:0	ALS high threshold upper byte



# TSL2571 LIGHT-TO-DIGITAL CONVERTER

TAOS117A – FEBRUARY 2011

## Persistence Register (0x0C)

The persistence register controls the filtering interrupt capabilities of the device. Configurable filtering is provided to allow interrupts to be generated after each ADC integration cycle or if the ADC integration has produced a result that is outside of the values specified by threshold register for some specified amount of time. ALS interrupts are generated using C0DATA.

**Table 7. Persistence Register**

	7	6	5	4	3	2	1	0	
PERS	Reserved						APERS		Address 0x0C

FIELD	BITS	DESCRIPTION		
Reserved	7:4	Reserved		
APERS	3:0	Interrupt persistence. Controls rate of interrupt to the host processor.		
		<b>FIELD VALUE</b>	<b>MEANING</b>	<b>INTERRUPT PERSISTENCE FUNCTION</b>
		0000	Every	Every ALS cycle generates an interrupt
		0001	1	1 value outside of threshold range
		0010	2	2 consecutive values out of range
		0011	3	3 consecutive values out of range
		0100	5	5 consecutive values out of range
		0101	10	10 consecutive values out of range
		0110	15	15 consecutive values out of range
		0111	20	20 consecutive values out of range
		1000	25	25 consecutive values out of range
		1001	30	30 consecutive values out of range
		1010	35	35 consecutive values out of range
		1011	40	40 consecutive values out of range
		1100	45	45 consecutive values out of range
		1101	50	50 consecutive values out of range
1110	55	55 consecutive values out of range		
1111	60	60 consecutive values out of range		

## Configuration Register (0x0D)

The configuration register sets the wait long time.

**Table 8. Configuration Register**

	7	6	5	4	3	2	1	0	
CONFIG	Reserved						WLONG	Reserved	Address 0x0D

FIELD	BITS	DESCRIPTION
Reserved	7:2	Reserved. Write as 0.
WLONG	1	Wait Long. When asserted, the wait cycles are increased by a factor 12X from that programmed in the WTIME register.
Reserved	0	Reserved. Write as 0.

### Control Register (0x0F)

The Control register provides eight bits of miscellaneous control to the analog block. These bits typically control functions such as gain settings and/or diode selection.

**Table 9. Control Register**

	7	6	5	4	3	2	1	0	
CONTROL	Reserved						AGAIN	Address 0x0F	
FIELD	BITS	DESCRIPTION							
Reserved	7:2	Reserved. Write bits as 0							
AGAIN	1:0	ALS Gain Control.							
		FIELD VALUE	ALS GAIN VALUE						
		00	1× gain						
		01	8× gain						
		10	16× gain						
		11	120× gain						

### ID Register (0x12)

The ID Register provides the value for the part number. The ID register is a read-only register.

**Table 10. ID Register**

	7	6	5	4	3	2	1	0	
ID	ID								Address 0x12
FIELD	BITS	DESCRIPTION							
ID	7:0	Part number identification						0x04 = TSL25711 & TSL25715	
								0x0D = TSL25713 & TSL25717	

### Status Register (0x13)

The Status Register provides the internal status of the device. This register is read only.

**Table 11. Status Register**

	7	6	5	4	3	2	1	0	
STATUS	Reserved		AINT	Reserved			AVALID	Address 0x13	
FIELD	BIT	DESCRIPTION							
Reserved	7:5	Reserved. Write as 0.							
AINT	4	ALS Interrupt. Indicates that the device is asserting an ALS interrupt.							
Reserved	3:1	Reserved.							
AVALID	0	ALS Valid. Indicates that the ALS CH0 / CH1 channels have completed an integration cycle.							



# TSL2571 LIGHT-TO-DIGITAL CONVERTER

TAOS117A – FEBRUARY 2011

## ADC Channel Data Registers (0x14 – 0x17)

ALS data is stored as two 16-bit values. To ensure the data is read correctly, a two-byte read I2C transaction should be used with auto increment protocol bits set in the command register. With this operation, when the lower byte register is read, the upper eight bits are stored in a shadow register, which is read by a subsequent read to the upper byte. The upper register will read the correct value even if additional ADC integration cycles end between the reading of the lower and upper registers.

Table 12. ADC Channel Data Registers

REGISTER	ADDRESS	BITS	DESCRIPTION
C0DATA	0x14	7:0	ALS CH0 data low byte
C0DATAH	0x15	7:0	ALS CH0 data high byte
C1DATA	0x16	7:0	ALS CH1 data low byte
C1DATAH	0x17	7:0	ALS CH1 data high byte

APPLICATION INFORMATION: HARDWARE

Typical Hardware Application

A typical hardware application circuit is shown in Figure 10. A 1- $\mu$ F low-ESR decoupling capacitor should be placed as close as possible to the  $V_{DD}$  pin.

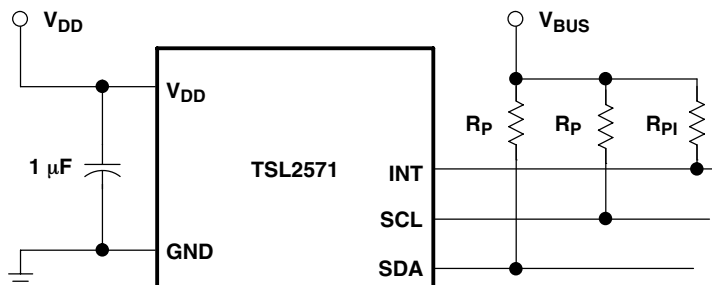

Figure 10. Typical Application Hardware Circuit

$V_{BUS}$  in Figure 10 refers to the I<sup>2</sup>C bus voltage, which is either  $V_{DD}$  or 1.8 V. Be sure to apply the specified I<sup>2</sup>C bus voltage shown in the Available Options table for the specific device being used.

The I<sup>2</sup>C signals and the Interrupt are open-drain outputs and require pull-up resistors. The pull-up resistor ( $R_P$ ) value is a function of the I<sup>2</sup>C bus speed, the I<sup>2</sup>C bus voltage, and the capacitive load. The TAOS EVM running at 400 kbps, uses 1.5-k $\Omega$  resistors. A 10-k $\Omega$  pull-up resistor ( $R_{PI}$ ) can be used for the interrupt line.

PCB Pad Layout

Suggested PCB pad layout guidelines for the Dual Flat No-Lead (FN) surface mount package are shown in Figure 11.

Note: Pads can be extended further if hand soldering is needed.

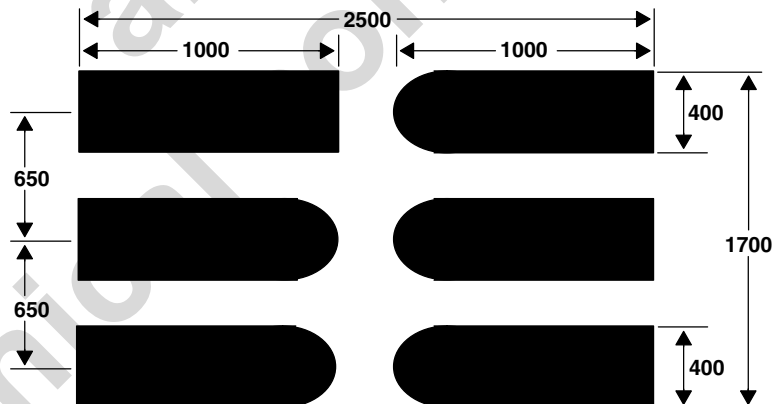

NOTES: A. All linear dimensions are in micrometers.  
B. This drawing is subject to change without notice.

Figure 11. Suggested FN Package PCB Layout

# TSL2571 LIGHT-TO-DIGITAL CONVERTER

TAOS117A – FEBRUARY 2011

## MECHANICAL DATA

PACKAGE FN

Dual Flat No-Lead

TOP VIEW

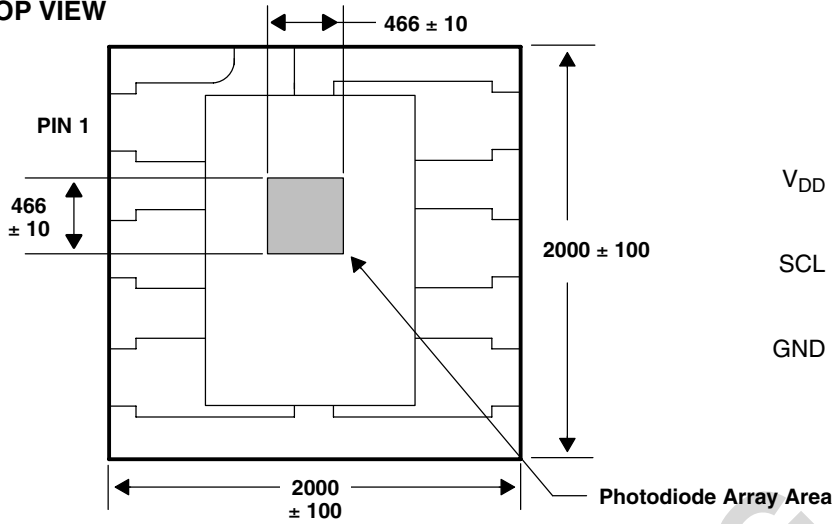

PIN OUT  
TOP VIEW

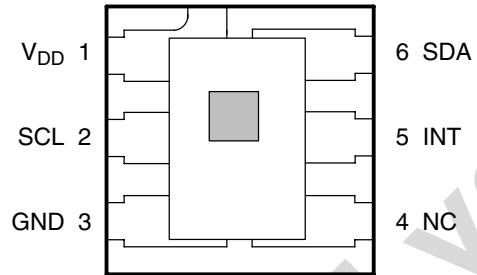

END VIEW

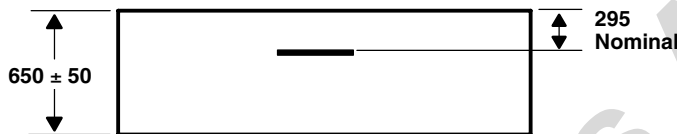

SIDE VIEW

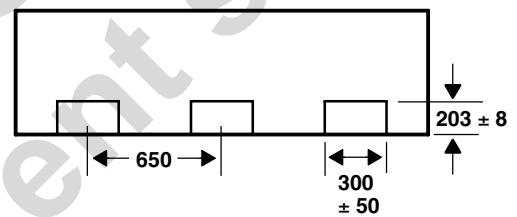

BOTTOM VIEW

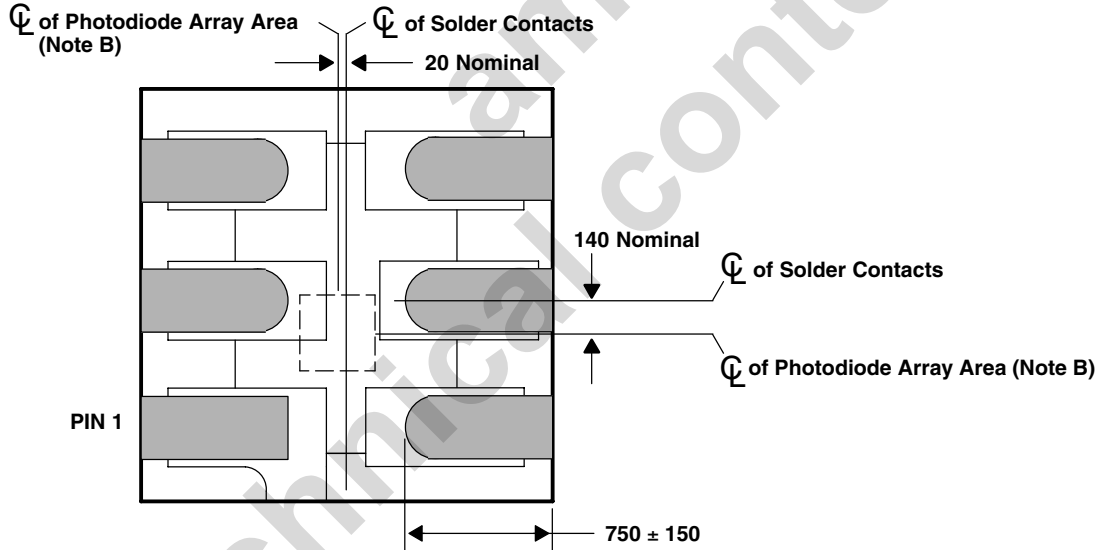

Lead Free

- NOTES: A. All linear dimensions are in micrometers. Dimension tolerance is  $\pm 20 \mu\text{m}$  unless otherwise noted.  
 B. The die is centered within the package within a tolerance of  $\pm 3$  mils.  
 C. Package top surface is molded with an electrically nonconductive clear plastic compound having an index of refraction of 1.55.  
 D. Contact finish is copper alloy A194 with pre-plated NiPdAu lead finish.  
 E. This package contains no lead (Pb).  
 F. This drawing is subject to change without notice.

Figure 12. Package FN — Dual Flat No-Lead Packaging Configuration

MECHANICAL DATA

TOP VIEW

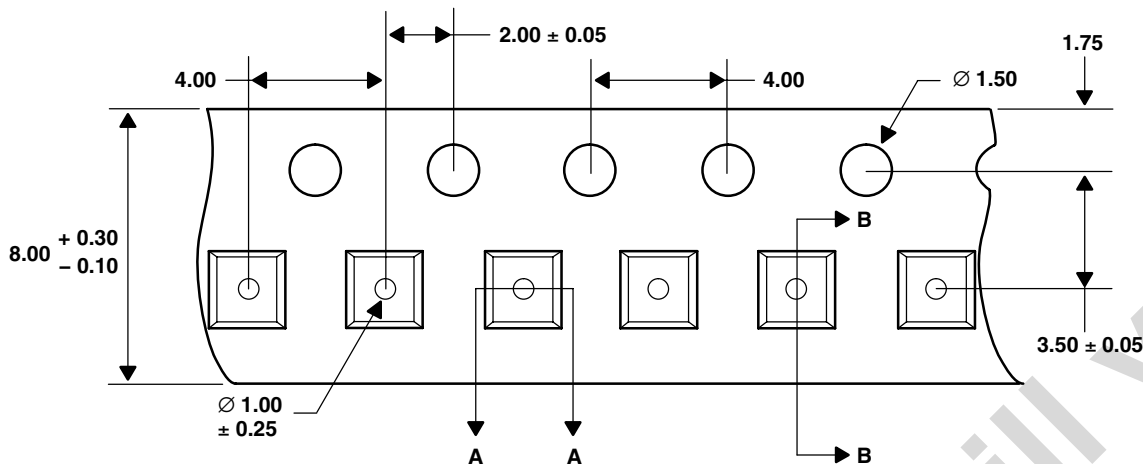

DETAIL A

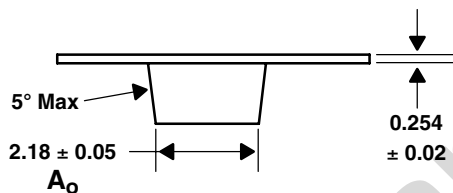

DETAIL B

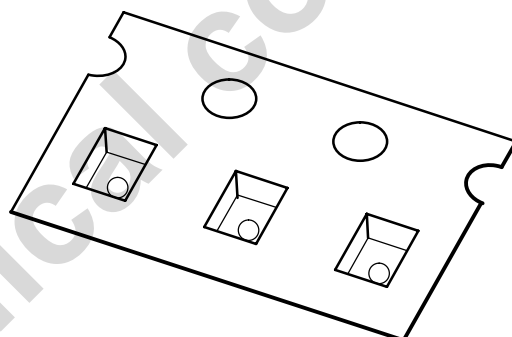
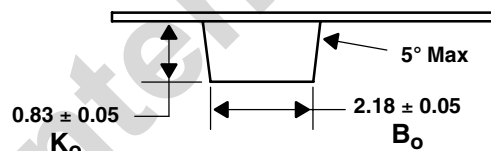

- NOTES: A. All linear dimensions are in millimeters. Dimension tolerance is  $\pm 0.10$  mm unless otherwise noted.  
 B. The dimensions on this drawing are for illustrative purposes only. Dimensions of an actual carrier may vary slightly.  
 C. Symbols on drawing  $A_o$ ,  $B_o$ , and  $K_o$  are defined in ANSI EIA Standard 481-B 2001.  
 D. Each reel is 178 millimeters in diameter and contains 3500 parts.  
 E. TAOS packaging tape and reel conform to the requirements of EIA Standard 481-B.  
 F. In accordance with EIA standard, device pin 1 is located next to the sprocket holes in the tape.  
 G. This drawing is subject to change without notice.

Figure 13. Package FN Carrier Tape

**MANUFACTURING INFORMATION**

The FN package has been tested and has demonstrated an ability to be reflow soldered to a PCB substrate.

The solder reflow profile describes the expected maximum heat exposure of components during the solder reflow process of product on a PCB. Temperature is measured on top of component. The components should be limited to a maximum of three passes through this solder reflow profile.

**Table 13. Solder Reflow Profile**

PARAMETER	REFERENCE	DEVICE
Average temperature gradient in preheating		2.5°C/sec
Soak time	$t_{soak}$	2 to 3 minutes
Time above 217°C (T1)	$t_1$	Max 60 sec
Time above 230°C (T2)	$t_2$	Max 50 sec
Time above $T_{peak} - 10^\circ\text{C}$ (T3)	$t_3$	Max 10 sec
Peak temperature in reflow	$T_{peak}$	260°C
Temperature gradient in cooling		Max -5°C/sec

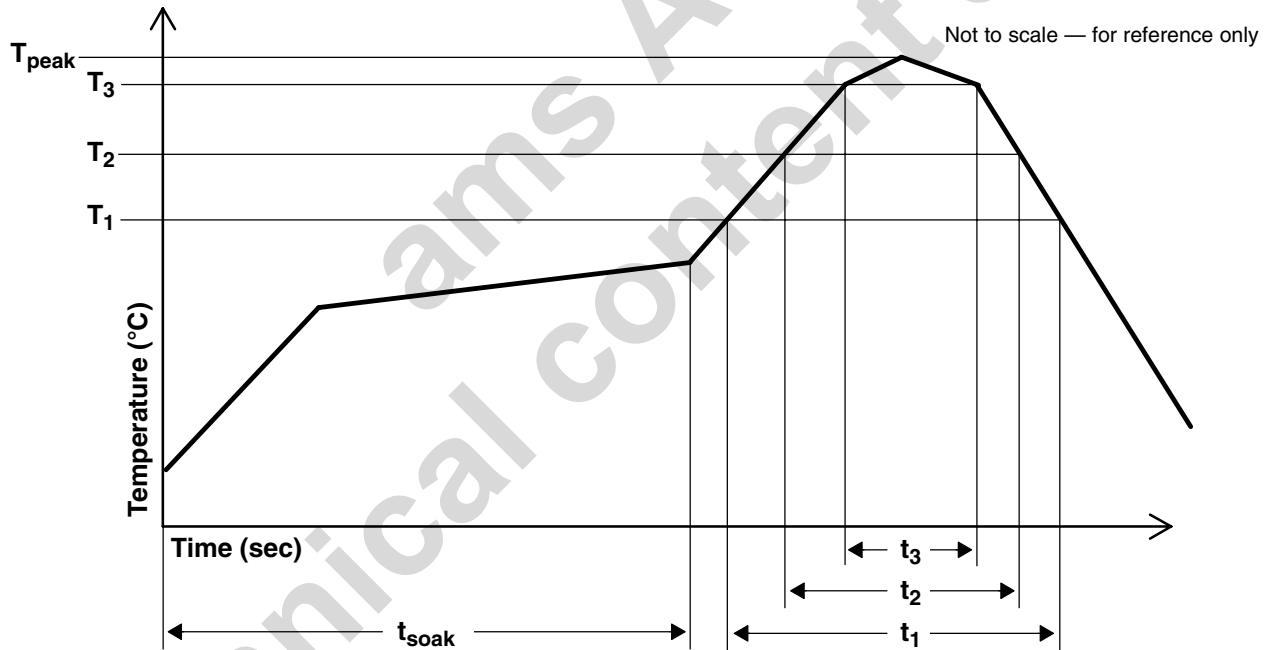

**Figure 14. Solder Reflow Profile Graph**

---

## MANUFACTURING INFORMATION

### Moisture Sensitivity

Optical characteristics of the device can be adversely affected during the soldering process by the release and vaporization of moisture that has been previously absorbed into the package. To ensure the package contains the smallest amount of absorbed moisture possible, each device is dry-baked prior to being packed for shipping. Devices are packed in a sealed aluminized envelope called a moisture barrier bag with silica gel to protect them from ambient moisture during shipping, handling, and storage before use.

The FN package has been assigned a moisture sensitivity level of MSL 3 and the devices should be stored under the following conditions:

Temperature Range	5°C to 50°C
Relative Humidity	60% maximum
Total Time	12 months from the date code on the aluminized envelope — if unopened
Opened Time	168 hours or fewer

Rebaking will be required if the devices have been stored unopened for more than 12 months or if the aluminized envelope has been open for more than 168 hours. If rebaking is required, it should be done at 50°C for 12 hours.



# TSL2571 LIGHT-TO-DIGITAL CONVERTER

TAOS117A – FEBRUARY 2011

---

**PRODUCTION DATA** — information in this document is current at publication date. Products conform to specifications in accordance with the terms of Texas Advanced Optoelectronic Solutions, Inc. standard warranty. Production processing does not necessarily include testing of all parameters.

## **LEAD-FREE (Pb-FREE) and GREEN STATEMENT**

**Pb-Free (RoHS)** TAOS' terms *Lead-Free* or *Pb-Free* mean semiconductor products that are compatible with the current RoHS requirements for all 6 substances, including the requirement that lead not exceed 0.1% by weight in homogeneous materials. Where designed to be soldered at high temperatures, TAOS Pb-Free products are suitable for use in specified lead-free processes.

**Green (RoHS & no Sb/Br)** TAOS defines *Green* to mean Pb-Free (RoHS compatible), and free of Bromine (Br) and Antimony (Sb) based flame retardants (Br or Sb do not exceed 0.1% by weight in homogeneous material).

**Important Information and Disclaimer** The information provided in this statement represents TAOS' knowledge and belief as of the date that it is provided. TAOS bases its knowledge and belief on information provided by third parties, and makes no representation or warranty as to the accuracy of such information. Efforts are underway to better integrate information from third parties. TAOS has taken and continues to take reasonable steps to provide representative and accurate information but may not have conducted destructive testing or chemical analysis on incoming materials and chemicals. TAOS and TAOS suppliers consider certain information to be proprietary, and thus CAS numbers and other limited information may not be available for release.

## **NOTICE**

Texas Advanced Optoelectronic Solutions, Inc. (TAOS) reserves the right to make changes to the products contained in this document to improve performance or for any other purpose, or to discontinue them without notice. Customers are advised to contact TAOS to obtain the latest product information before placing orders or designing TAOS products into systems.

TAOS assumes no responsibility for the use of any products or circuits described in this document or customer product design, conveys no license, either expressed or implied, under any patent or other right, and makes no representation that the circuits are free of patent infringement. TAOS further makes no claim as to the suitability of its products for any particular purpose, nor does TAOS assume any liability arising out of the use of any product or circuit, and specifically disclaims any and all liability, including without limitation consequential or incidental damages.

TEXAS ADVANCED OPTOELECTRONIC SOLUTIONS, INC. PRODUCTS ARE NOT DESIGNED OR INTENDED FOR USE IN CRITICAL APPLICATIONS IN WHICH THE FAILURE OR MALFUNCTION OF THE TAOS PRODUCT MAY RESULT IN PERSONAL INJURY OR DEATH. USE OF TAOS PRODUCTS IN LIFE SUPPORT SYSTEMS IS EXPRESSLY UNAUTHORIZED AND ANY SUCH USE BY A CUSTOMER IS COMPLETELY AT THE CUSTOMER'S RISK.

LUMENOLOGY, TAOS, the TAOS logo, and Texas Advanced Optoelectronic Solutions are registered trademarks of Texas Advanced Optoelectronic Solutions Incorporated.